

STATE OF NORTH CAROLINA  
**DEPARTMENT OF TRANSPORTATION**

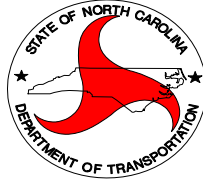

DIVISION FIVE

# CONTRACT PROPOSAL

COUNTY: WAKE

CONTRACT#: DE00085      FA#: N/A      WBS #: 17BP.5.R.35

**DESCRIPTION: REPLACEMENT OF BRIDGE #201 OVER  
LITTLE RIVER ON SR 2368 (GREEN PACE RD) IN WAKE COUNTY  
BID OPENING: MARCH 26, 2014**

**NOTICE:**

ALL BIDDERS SHALL COMPLY WITH ALL APPLICABLE LAWS REGULATING THE PRACTICE OF GENERAL CONTRACTING AS CONTAINED IN CHAPTER 87 OF THE GENERAL STATUTES OF NORTH CAROLINA WHICH REQUIRES THE BIDDER TO BE LICENSED BY THE NC LICENSING BOARD FOR CONTRACTORS WHEN BIDDING ON ANY NON-FEDERAL AID PROJECT WHERE THE BID IS \$30,000 OR MORE, EXCEPT FOR CERTAIN SPECIALTY WORK AS DETERMINED BY THE LICENSING BOARD. BIDDERS SHALL ALSO COMPLY WITH ALL OTHER APPLICABLE LAWS REGULATING THE PRACTICES OF ELECTRICAL, PLUMBING, HEATING AND AIR CONDITIONING AND REFRIGERATION CONTRACTING AS CONTAINED IN CHAPTER 87 OF THE GENERAL STATUTES OF NORTH CAROLINA. NOT WITHSTANDING THESE LIMITATIONS ON BIDDING, THE BIDDER WHO IS AWARDED ANY PROJECT SHALL COMPLY WITH CHAPTER 87 OF THE GENERAL STATUTES OF NORTH CAROLINA FOR LICENSING REQUIREMENTS WITHIN 60 CALENDAR DAYS OF BID OPENING, REGARDLESS OF FUNDING SOURCES.

---

NAME OF BIDDER

---

ADDRESS OF BIDDER

**RETURN BIDS TO:**

**NC DEPARTMENT OF TRANSPORTATION  
Michael J. Kneis, PE  
Division Project Manager  
North Carolina Department of Transportation  
2612 N Duke Street  
Durham, NC 27704**



<b>STANDARD PROVISIONS.....</b>	<b>7</b>
GENERAL .....	7
CONTRACT TIME AND LIQUIDATED DAMAGES.....	7
INTERMEDIATE CONTRACT TIME NUMBER 1 AND LIQUIDATED DAMAGES .....	7
PURCHASE ORDER CONTRACT PREQUALIFICATION.....	8
BIDS .....	8
AVAILABILITY OF FUNDS – TERMINATION OF CONTRACTS .....	8
CONTRACT PAYMENT AND PERFORMANCE BOND .....	8
DEFAULT OF CONTRACT .....	9
SUBLETTING OF CONTRACT.....	9
NOTIFICATION OF OPERATIONS.....	9
AUTHORITY OF THE ENGINEER.....	9
BANKRUPTCY.....	9
PARTIAL PAYMENT.....	9
PROMPT PAYMENT (SUBCONTRACTORS).....	9
LIABILITY INSURANCE .....	10
SUPERVISION BY CONTRACTOR .....	10
POSTED WEIGHT LIMITS .....	10
INSPECTION.....	10
MATERIALS AND TESTING .....	10
EROSION CONTROL .....	11
UTILITY CONFLICTS.....	11
SAFETY AND ACCIDENT PROTECTION .....	11
PLAN, DETAIL AND QUANTITY ADJUSTMENTS.....	11
GIFTS FROM VENDORS AND CONTRACTORS .....	11
EMPLOYMENT .....	12
SAFETY VESTS .....	12
CONTRACTOR CLAIM SUBMITTAL FORM .....	12
TEMPORARY TRAFFIC CONTROL DEVICES .....	12
STATE HIGHWAY ADMINISTRATOR TITLE CHANGE.....	12
LOCATING EXISTING UNDERGROUND UTILITIES .....	13
RESOURCE CONSERVATION.....	13
DOMESTIC STEEL .....	13
SHOULDER AND SLOPE BORROW .....	13
MATERIALS.....	14
<b>PROJECT SPECIAL PROVISIONS.....</b>	<b>22</b>
CONSTRUCTION METHODS.....	22
SITE INVESTIGATION AND REPRESENTATION.....	22
CONTROL OF EROSION, SILT AND POLLUTION .....	22
MINORITY BUSINESS ENTERPRISE AND WOMEN BUSINESS ENTERPRISE (DIVISIONS)	
.....	22
PROSECUTION AND PROGRESS .....	32
PROGRESS SCHEDULE .....	32
DRIVEWAYS AND PRIVATE PROPERTY .....	32
SHOULDER AND FILL SLOPE MATERIAL.....	32
SUBSURFACE INFORMATION .....	33
NO MAJOR CONTRACT ITEMS .....	33
NO SPECIALTY ITEMS .....	33
PLANT AND PEST QUARANTINES .....	33
CLEARING AND GRUBBING - METHOD III.....	34
PIPE INSTALLATION .....	34
BRIDGE APPROACH FILLS.....	34
ASPHALT PAVEMENTS - SUPERPAVE.....	36
ASPHALT BINDER CONTENT OF ASPHALT PLANT MIXES.....	38

FUEL PRICE ADJUSTMENT .....	38
PRICE ADJUSTMENT - ASPHALT BINDER FOR PLANT MIX .....	38
GUARDRAIL ANCHOR UNITS, TYPE 350.....	39
REMOVAL OF EXISTING PAVEMENT MARKERS.....	40
<i>ROADWAY STANDARD DRAWINGS</i> FOR PAVEMENT MARKINGS AND MARKERS.....	40
EROSION AND SEDIMENT CONTROL/STORMWATER CERTIFICATION .....	40
PROCEDURE FOR MONITORING BORROW PIT DISCHARGE .....	44
LAWN TYPE APPEARANCE .....	45
MOWING .....	45
MINIMIZE REMOVAL OF VEGETATION .....	45
NATIVE GRASS SEEDING AND MULCHING.....	45
RESPONSE FOR EROSION CONTROL.....	46
SAFETY FENCE AND JURSDICTIONAL FLAGGING.....	47
NCDOT GENERAL SEED SPECIFICATION FOR SEED QUALITY .....	49
STABILIZATION REQUIREMENTS .....	51
SEEDING AND MULCHING .....	51
TEMPORARY SEEDING.....	52
SUPPLEMENTAL SEEDING .....	52
FERTILIZER TOPDRESSING.....	52
STOCKPILE AREAS.....	52
ACCESS AND HAUL ROADS.....	52
WASTE AND BORROW SOURCES .....	52
COIR FIBER MAT.....	53
COIR FIBER WATTLE.....	54
SILT FENCE COIR FIBER WATTLE BREAK.....	55
FLOATING TURBIDITY CURTAIN .....	56
IMPERVIOUS DIKE.....	57
ENVIRONMENTALLY SENSITIVE AREAS .....	57
REFORESTATION .....	58
PERMITS.....	61
<b>STRUCTURE PROVISIONS .....</b>	<b>63</b>
<b>STANDARD SPECIAL PROVISION.....</b>	<b>I</b>
ERRATA.....	I
MINIMUM WAGES.....	II
ON-THE-JOB TRAINING.....	II
<u>LISTING OF MBE WBE SUBCONTRACTORS</u>	
<u>AWARD LIMITS ON MULTIPLE PROJECTS</u>	
<u>BIDFORM</u>	
<u>EXECUTION OF BID – NON-COLLUSION AFFIDAVIT, DEBARMENT CERTIFICATION AND</u>	
<u>GIFT BAN CERTIFICATION</u>	
<u>DEBARMENT CERTIFICATION</u>	
<u>BID ACCEPTANCE SHEET</u>	
<u>GEOTECHNICAL ATTACHMENT</u>	
<u>17BP.5.R.35 PERMIT PACKAGE</u>	
<u>17BP.5.R.35 PLANS</u>	

## **INSTRUCTIONS TO BIDDERS**

### **PLEASE READ ALL INSTRUCTIONS CAREFULLY BEFORE PREPARING AND SUBMITTING YOUR BID.**

**All bids shall be prepared and submitted in accordance with the following requirements. Failure to comply with any requirement shall cause the bid to be considered irregular and shall be grounds for rejection of the bid. Bidders must be prequalified for the type of work they wish to perform prior to submitting a bid.**

1. The bid form furnished by NCDOT with the proposal shall be used and shall not be altered in any manner. **DO NOT SEPARATE THE BID FORM FROM THE PROPOSAL!**
2. All entries on the bid form, including signatures, shall be written in ink.
3. The Bidder shall submit a unit price for every item on the bid form. The unit prices for the various contract items shall be written in figures. **\*\*\*Unit prices must be limited to TWO decimal places.\*\*\***
4. An amount bid shall be entered on the bid form for every item. The amount bid for each item shall be determined by multiplying each unit bid by the quantity for that item, and shall be written in figures in the "Amount Bid" column of the form.
5. The total amount bid shall be written in figures in the proper place on the bid form. The total amount shall be determined by adding the amounts bid for each item.
6. Changes in any entry shall be made by marking through the entry in ink and making the correct entry adjacent thereto in ink. A representative of the Bidder shall initial the change in ink. Do not use "White Out" or similar product to make corrections.
7. The bid shall be properly executed. All bids shall show the following information:
  - a. Name of individual, firm, corporation, partnership, or joint venture submitting bid.
  - b. Name of individual or representative submitting bid and position or title.
  - c. Name, signature, and position or title of witness.
  - d. Federal Identification Number
  - e. Contractor's License Number
8. Bids submitted by corporations shall bear the seal of the corporation.
9. The bid shall not contain any unauthorized additions, deletions, or conditional bids.
10. The bidder shall not add any provision reserving the right to accept or reject an award, or to enter into a contract pursuant to an award.
11. **THE PROPOSAL WITH THE BID FORM STILL ATTACHED SHALL BE PLACED IN A SEALED ENVELOPE AND SHALL HAVE BEEN DELIVERED TO AND RECEIVED IN THE NCDOT DIV. FIVE OFFICE, 2612 North Duke Street Durham, NC 27704 BY 2:00 p.m., on Wednesday, March 26, 2014.**
12. The sealed bid must display the following statement on the front of the sealed envelope:  
**"QUOTATION FOR 17BP.5.R.35, REPLACEMENT OF BRIDGE #201 ON SR 2368 IN WAKE COUNTY TO BE OPENED AT 2:00 P.M. ON WEDNESDAY, MARCH 26, 2014."**
13. If delivered by mail, the sealed envelope shall be placed in another sealed envelope and the outer envelope shall be addressed as follows:

**N. C. DEPARTMENT OF TRANSPORTATION  
Attn: Michael J. Kneis, PE  
2612 N Duke Street  
Durham, NC 27704**

#### **AWARD OF CONTRACT**

**The award of the contract, if it be awarded, will be made to the lowest responsible Bidder in accordance with Section 102 (excluding 102-10) of the Standard Specifications for Roads and Structures 2012. The lowest responsible Bidder will be notified that his bid has been accepted and that he has been awarded the contract. NCDOT reserves the right to reject all bids.**



# STANDARD PROVISIONS

## GENERAL

### Location and Description of Bridge

17BP.5.R.35 is the replacement of bridge number 201 in Wake County. Bridge No. 201 was built in 1958 and is located on SR 2368 over Little River. The bridge has an overall length of 121 feet and consists of four (4) spans, timber piles and concrete caps with prestressed concrete channels.

### Description of Work

This work shall consist of furnishing and installing a prestressed concrete cored slab bridge; removal of the existing structure; clearing and grubbing; excavation and embankment; installation of guardrail, roadway base course and pavement; construction of substructure and superstructure; construction of approach slabs; grading within limits of the project; placement of rip rap; temporary erosion control; seeding and mulching; drainage; traffic control, temporary and final pavement markings and all other incidental items necessary to complete the project as specified and shown on the plans.

All work and materials shall be in accordance with the provisions of the General Guidelines of this contract, the Project Special Provisions, the North Carolina Department of Transportation Standard Specifications for Roads and Structures 2012, the North Carolina Department of Transportation Roadway Standard Drawings, and the current edition of the Manual of Uniform Traffic Control Devices (MUTCD).

The Contractor shall keep himself fully informed of all Federal, State and local laws, ordinances, and regulations, and shall comply with the provisions of Section 107 of the Standard Specifications.

## CONTRACT TIME AND LIQUIDATED DAMAGES

The date of availability for this contract will be **May 12, 2014**.

The completion date for this contract is **December 5, 2014**.

The liquidated damages for this contract will be **Six Hundred Dollars (\$600.00)** per calendar day. After award of the project, the Contractor shall contact the Engineer to schedule a preconstruction conference and notify the Engineer of his expected date for beginning work.

## INTERMEDIATE CONTRACT TIME NUMBER 1 AND LIQUIDATED DAMAGES

(7-1-95) (Rev. 2-21-12)

108

SP1 G13 A

Except for that work required under the Project Special Provisions entitled *Planting, Reforestation* and/or *Permanent Vegetation Establishment*, included elsewhere in this proposal, the Contractor will be required to complete all work included in this contract and shall place and maintain traffic on same.

The date of availability for this intermediate contract time is **May 12, 2014**.

The completion date for this intermediate contract time is **November 10, 2014**.

The liquidated damages for this intermediate contract time are **Six Hundred Dollars (\$ 600.00)** per calendar day.

Upon apparent completion of all the work required to be completed by this intermediate date, a final inspection will be held in accordance with Article 105-17 and upon acceptance, the Department will assume responsibility for the maintenance of all work except *Planting, Reforestation* and/or *Permanent Vegetation Establishment*. The Contractor will be responsible for and shall make corrections of all damages to the completed roadway caused by his planting operations, whether occurring prior to or after placing traffic through the project.

## PURCHASE ORDER CONTRACT PREQUALIFICATION

Beginning **July 1, 2009**, any firm that wishes to perform work on Division Purchase Order Contracts as either the prime contractor or as a subcontractor on the project must be prequalified for the type of work they wish to perform. Firms that wish to bid on these projects as the prime contractor must be prequalified prior to submitting a bid. Firms that wish to perform as a subcontractor to the prime contractor must be prequalified prior to beginning work on the project.

For the purposes of prequalification, any firm that is currently prequalified as a prime or a subcontractor on central let projects for the appropriate work codes is considered eligible to work and/or bid on Purchase Order Contracts as long as other items such as bonding and license requirements for the contract are met.

Information regarding the requirements to become prequalified as a Purchase Order Contract contractor, including the application to become prequalified if you are not already prequalified, can be found at the following website: <http://www.ncdot.org/business/howtogetstarted/>

### BIDS

In accordance with GS 136-28.1(b), if the total bid amount of the contract exceeds \$2.5 million, the bid will not be considered for award.

### AVAILABILITY OF FUNDS – TERMINATION OF CONTRACTS

(5-20-08)

Z-2

*General Statute 143C-6-11. (h) Highway Appropriation* is hereby incorporated verbatim in this contract as follows:

(h) Amounts Encumbered. – Transportation project appropriations may be encumbered in the amount of allotments made to the Department of Transportation by the Director for the estimated payments for transportation project contract work to be performed in the appropriation fiscal year. The allotments shall be multiyear allotments and shall be based on estimated revenues and shall be subject to the maximum contract authority contained in *General Statute 143C-6-11(c)*. Payment for transportation project work performed pursuant to contract in any fiscal year other than the current fiscal year is subject to appropriations by the General Assembly. Transportation project contracts shall contain a schedule of estimated completion progress, and any acceleration of this progress shall be subject to the approval of the Department of Transportation provided funds are available. The State reserves the right to terminate or suspend any transportation project contract, and any transportation project contract shall be so terminated or suspended if funds will not be available for payment of the work to be performed during that fiscal year pursuant to the contract. In the event of termination of any contract, the contractor shall be given a written notice of termination at least 60 days before completion of scheduled work for which funds are available. In the event of termination, the contractor shall be paid for the work already performed in accordance with the contract specifications.

Payment will be made on any contract terminated pursuant to the special provision in accordance with Subarticle 108-13(E) of the *2012 Standard Specifications*.

### CONTRACT PAYMENT AND PERFORMANCE BOND

REVISED 8/24/10

A performance bond in the amount of one hundred percent (100%) of the contract amount, conditioned upon the faithful performance of the contract in accordance with specifications and conditions of the contract is required for Construction contracts of **\$300,000** or more. Such bond shall be solely for the protection of the North Carolina Department of Transportation and the State of North Carolina.

A payment bond in the amount of one hundred percent (100%) of the contract amount, conditioned upon the prompt payment for all labor or materials for which the Contractor, or his subcontractors, are liable is required for Construction contracts greater than **\$300,000**. The payment bond shall be solely for the protection of persons or firms furnishing materials or performing labor for this contract for which the Contractor is liable.



**DEFAULT OF CONTRACT**

The Department of Transportation shall have the right to declare a default of contract for breach by the Contractor of any material term or condition of the contract. Default of contract shall be in accordance with the terms, conditions, and procedures of Article 108-9 of the Standard Specifications.

**SUBLETTING OF CONTRACT**

The Contractor shall not sublet, sell, transfer, assign or otherwise dispose of this contract or any portion thereof; or his right, title, or interest therein; without written consent of the Engineer. Subletting of this contract or any portion of the contract shall conform to the requirements of Article of 108-6 of the Standard Specifications.

**NOTIFICATION OF OPERATIONS**

The Contractor shall notify the Engineer Five (5) working days in advance of beginning work on this project.

**AUTHORITY OF THE ENGINEER**

The Engineer for this project shall be the Division Engineer, Division Five, Division of Highways, North Carolina Department of Transportation, acting directly or through his duly authorized representative.

The Engineer will decide all questions which may arise as to the quality and acceptability of work performed and as to the rate of progress of the work; all questions which may arise as to the interpretation of the contract; and all questions as to the acceptable fulfillment of the contract on the part of the Contractor. His decision shall be final and he shall have executive authority to enforce and make effective such decisions and orders as the Contractor fails to carry out promptly.

**BANKRUPTCY**

The Department of Transportation, at its option, may terminate the contract upon the filing by the contractor of any petition for protection under the provisions of the Federal Bankruptcy Act.

**PARTIAL PAYMENT**

The Contractor may submit a request for partial payment on a monthly basis, or other interval as approved by the Engineer. The amount of partial payments will be based on the work accomplished and accepted as the last day of the approved pay period. All requests for payment shall be made on the form furnished to the Contractor by the Department of Transportation. The form shall be completely and legibly filled out with all appropriate information supplied and shall be signed by an authorized representative of the Contractor. Minority Business Enterprise (MBE), Women’s Business Enterprise (WBE) and/or Disadvantage Business Enterprise (DBE) participation shall be listed in the appropriate spaces on all requests for payment. If there is no participation the word “None” or the figure “0” shall be entered. One hundred percent (100%) payment shall be made after successful completion of the work as verified by the final inspection.

**PROMPT PAYMENT (SUBCONTRACTORS)**

Prompt Payment of Monies Due Subcontractors, Second Tier Subcontractors and Material Suppliers and Release of Retainage

Contractors at all levels; prime, subcontractor, or second tier contractor, shall within seven calendar days of receipt of monies, resulting from work performed on the project or services rendered, pay subcontractors, second tier subcontractors, or material suppliers, as appropriate. This seven-day period begins upon knowledgeable receipt by the contracting firm obligated to make a subsequent periodic or final payment. These prompt payment requirements will be met if each firm mails the payment to the next level firm by evidence of postmark within the seven-day period.

This provision for prompt payment shall be incorporated into each subcontract or second tier subcontract issued for work performed on the project or for services provided.

**DE00085**

Failure of any entity to make prompt payment as defined herein may result in (1) withholding of money due to that entity in the next partial payment until such assurances are made satisfactory to this provision; or (2) removal of an approved contractor from the prequalified bidders list or the removal of other entities from the approved subcontractors list.

**LIABILITY INSURANCE**

The Contractor shall provide liability insurance conforming to the requirements of Article of 107-15 of the Standard Specifications.

Upon execution of the contract, provide evidence of the above insurance requirements to the Engineer.

**SUPERVISION BY CONTRACTOR**

At all times during the life of the project the Contractor shall provide one permanent employee who shall have the authority and capability for overall responsibility of the project and who shall be personally available at the work site within 24 hours notice. Such employee shall be fully authorized to conduct all business with the subcontractors, to negotiate and execute all supplemental agreements, and to execute the orders or directions of the Engineer.

At all times that work is actually being performed, the Contractor shall have present on the project one competent individual who is authorized to act in a supervisory capacity over all work on the project, including work subcontracted. The individual who has been so authorized shall be experienced in the type of work being performed and shall be fully capable of managing, directing, and coordinating the work; of reading and thoroughly understanding the contract; and receiving and carrying out directions from the Engineer or his authorized representatives. He shall be an employee of the Contractor unless otherwise approved by the Engineer.

The Contractor may, at his option, designate one employee to meet the requirements of both positions. However, whenever the designated employee is absent from the work site, an authorized individual qualified to act in a supervisory capacity on the project shall be present.

**POSTED WEIGHT LIMITS**

The Contractor's attention is directed to the fact that many Primary and Secondary Roads and bridges are posted with weight limits less than the legal limit. The Contractor will not be allowed to exceed the posted weight limits in transporting materials and/or equipment to the projects, unless otherwise approved by the Engineer. The Contractor should make a thorough examination of all projects and haul routes.

**INSPECTION**

All work shall be subject to inspection by the Engineer at any time. Routinely, the Engineer will make periodic inspections of the completed work. It will be the responsibility of the Contractor to keep the Engineer informed of his proposed work plan and to submit written reports of work accomplished on a frequency to be determined by the Engineer

**MATERIALS AND TESTING**

The Engineer reserves the right to perform all sampling and testing in accordance with Section 106 of the Standard Specifications and the Department's "Materials and Test Manual." However the Engineer may reduce the frequency of sampling and testing where he deems it appropriate for the project under construction.

The Contractor shall furnish the applicable certifications and documentation for all materials as required by the Standard Specifications. Material which is not properly certified will not be accepted.

Delivery tickets for all asphalt material shall be furnished in accordance with Section 106-7 of the Standard Specifications and shall include the following information:

1. NCDOT Work Order Number
2. Date
3. Time issued
4. Type of Material
5. Gross weight

**DE00085**

6. Tare Weight
7. Net weight of material
8. Quarry or plant Location
9. Truck Number
10. Contractor's name
11. Public weighmaster's stamp or number
12. Public weighmaster's signature or initials in ink

All steel products which are permanently incorporated into this project shall be domestically produced. The Contractor shall furnish a notarized certification certifying that steel products conform to this requirement.

The Contractor shall furnish the applicable certifications and documentation for all materials as required by the Standard Specifications. Material which is not properly certified will not be accepted.

**EROSION CONTROL**

The Contractor shall exercise every reasonable precaution throughout the life of the project to prevent erosion and siltation. Silt fence and erosion control measures shall be installed in accordance with the plans for this project, Division 16 of the Standard Specifications, and in locations directed by the Engineer or his representative.

**UTILITY CONFLICTS**

It shall be the responsibility of the Contractor to contact all affected utility owners and determine the precise locations of all utilities prior to beginning construction. Utility owners shall be contacted a minimum of 48 hours prior to the commencement of operations. Special care shall be used in working around or near existing utilities, protecting them when necessary to provide uninterrupted service. In the event that any utility service is interrupted, the Contractor shall notify the utility owner immediately and shall cooperate with the owner, or his representative, in the restoration of service in the shortest time possible.

The Contractor shall adhere to all applicable regulations and follow accepted safety procedures when working in the vicinity of utilities in order to ensure the safety of construction personnel and the public.

The Contractor will not be responsible for the adjustment of any conflicting utilities at the bridge site prior to the date of availability.

**SAFETY AND ACCIDENT PROTECTION**

In accordance with Article 107-21 of the Standard Specifications, the Contractor shall comply with all applicable Federal, State, and local laws, ordinances, and regulations governing safety, health, and sanitation, and shall provide all safeguards, safety devices, and protective equipment, and shall take any other needed actions, on his own responsibility that are reasonably necessary to protect the life and health of employees on the job and the safety of the public, and to protect property in connection with the performance of the work covered by the contract.

**PLAN, DETAIL AND QUANTITY ADJUSTMENTS**

The Department reserves the right to make, at any time during the progress of the work, such alterations in plans or the details of construction as may be found necessary or desirable by the Engineer to complete the project.

**GIFTS FROM VENDORS AND CONTRACTORS**

(12-15-09)

SP1 G152

By Executive Order 24, issued by Governor Perdue, and *N.C. G.S. § 133-32*, it is unlawful for any vendor or contractor (i.e. architect, bidder, contractor, construction manager, design professional, engineer, landlord, offeror, seller, subcontractor, supplier, or vendor), to make gifts or to give favors to any State employee of the Governor's Cabinet Agencies (i.e. Administration, Commerce, Correction, Crime Control and Public Safety, Cultural Resources, Environment and Natural Resources, Health and Human Services, Juvenile Justice and Delinquency Prevention, Revenue, Transportation, and the Office of the Governor). This prohibition covers those vendors and contractors who:

- (1) have a contract with a governmental agency; or
- (2) have performed under such a contract within the past year; or
- (3) anticipate bidding on such a contract in the future.

For additional information regarding the specific requirements and exemptions, vendors and contractors are encouraged to review Executive Order 24 and *G.S. § 133-32*.

**DE00085**

Executive Order 24 also encouraged and invited other State Agencies to implement the requirements and prohibitions of the Executive Order to their agencies. Vendors and contractors should contact other State Agencies to determine if those agencies have adopted Executive Order 24.

**EMPLOYMENT**

(11-15-11) (Rev. 1-17-12)

108, 102

RG184

Revise the *2012 Standard Specifications* as follows:

**Page 1-20, Subarticle 102-15(O)**, delete and replace with the following:

(O) Failure to restrict a former Department employee as prohibited by Article 108-5.

**Page 1-65, Article 108-5 Character of Workmen, Methods, and Equipment, line 32**, delete all of line 32, the first sentence of the second paragraph and the first word of the second sentence of the second paragraph.

**SAFETY VESTS**

**All Contractors' personnel, all subcontractors and their personnel, and any material suppliers and their personnel must wear an OSHA approved reflective vest or outer garment at all times while on the project.**

**CONTRACTOR CLAIM SUBMITTAL FORM**

If the Contractor elects to file a written claim or requests an extension of contract time, it shall be submitted on the *Contractor Claim Submittal Form (CCSF)* available through the Construction Unit or [http://ncdot.org/doh/operations/dp\\_chief\\_eng/constructionunit/forms/ccfs-1.pdf](http://ncdot.org/doh/operations/dp_chief_eng/constructionunit/forms/ccfs-1.pdf)

Any claims for additional compensation and/or extensions of the completion date shall be submitted to the Division Engineer in writing, with detailed justification, **prior** to submitting the final invoice payment. Once an invoice is received and accepted that is marked as "Final", the Contractor shall be barred from recovery.

**TEMPORARY TRAFFIC CONTROL DEVICES**

(1-17-12)

1105

R11 R05

Revise the *2012 Standard Specifications* as follows:

**Page 11-5, Article 1105-6 Measurement and Payment**, add the following paragraph after line 24:

Partial payments will be made on each payment estimate based on the following: 50% of the contract lump sum price bid will be paid on the first monthly estimate and the remaining 50% of the contract lump sum price bid will be paid on each subsequent estimate based on the percent of the project completed.

**STATE HIGHWAY ADMINISTRATOR TITLE CHANGE**

(9-18-12)

SP1 G185

Revise the *2012 Standard Specifications* as follows:

Replace all references to "State Highway Administrator" with "Chief Engineer".

**LOCATING EXISTING UNDERGROUND UTILITIES**

(3-20-12)

105

SP1 G115

Revise the *2012 Standard Specifications* as follows:

**Page 1-43, Article 105-8, line 28, after the first sentence,** add the following:

Identify excavation locations by means of pre-marking with white paint, flags, or stakes or provide a specific written description of the location in the locate request.

**RESOURCE CONSERVATION**

(5-21-13)

104-13

SP1 G118

In accordance with North Carolina Executive Order 156, NCGS 130A-309.14(2), and NCGS 136-28.8, it is the policy of the Department to aid in the reduction of materials that become a part of our solid waste stream, to divert materials from landfills, and to find ways to recycle and reuse materials for the benefit of the Citizens of North Carolina.

Initiate, develop and use products and construction methods that incorporate the use of recycled or solid waste products in accordance with Article 104-13 of the *2012 Standard Specifications*. Report the quantities of reused or recycled materials either incorporated in the project or diverted from landfills on the Project Construction Reuse and Recycling Reporting Form.

A location-based tool for finding local recycling facilities and the Project Construction Reuse and Recycling Reporting Form are available at:

<http://connect.ncdot.gov/resources/Environmental/Pages/North-Carolina-Recycling-Locations.aspx>

**DOMESTIC STEEL**

(4-16-13)

106

SP1 G120

Revise the *2012 Standard Specifications* as follows:

**Page 1-49, Subarticle 106-1(B) Domestic Steel, lines 2-7,** replace the first paragraph with the following:

All steel and iron products that are permanently incorporated into this project shall be produced in the United States except minimal amounts of foreign steel and iron products may be used provided the combined material cost of the items involved does not exceed 0.1% of the total amount bid for the entire project or \$2,500, whichever is greater. If invoices showing the cost of the material are not provided, the amount of the bid item involving the foreign material will be used for calculations. This minimal amount of foreign produced steel and iron products permitted for use is not applicable to high strength fasteners. Domestically produced high strength fasteners are required.

**SHOULDER AND SLOPE BORROW**

(3-19-13)

1019

SP10 R10

Use soil in accordance with Section 1019 of the *2012 Standard Specifications*. Use soil consisting of loose, friable, sandy material with a PI greater than 6 and less than 25 and a pH ranging from 5.5 to 7.0.

Soil with a pH ranging from 4.0 to 5.5 will be accepted without further testing if additional limestone is provided in accordance with the application rates shown in Table 1019-1A. Soil type is identified during the soil analysis. Soils with a pH above 7.0 require acidic amendments to be added. Submit proposed acidic amendments to the Engineer for review and approval. Soils with a pH below 4.0 or that do not meet the PI requirements shall not be used.

<b>TABLE 1019-1A</b>			
<b>ADDITIONAL LIMESTONE APPLICATION RATE TO RAISE pH</b>			
<b>pH TEST RESULT</b>	<b>Sandy Soils Additional Rate (lbs. / Acre)</b>	<b>Silt Loam Soils Additional Rate (lbs. / Acre)</b>	<b>Clay Loam Soils Additional Rate (lbs. / Acre)</b>
4.0 - 4.4	1,000	4,000	6,000
4.5 - 4.9	500	3,000	5,000
5.0 - 5.4	NA	2,000	4,000

Note: Limestone application rates shown in this table are in addition to the standard rate of 4000 lbs. / acre required for seeding and mulching.

No direct payment will be made for providing additional lime or acidic amendments for Ph adjustment.

### **MATERIALS**

(2-21-12) (Rev. 1-21-14)

1000, 1005, 1024, 1050, 1056, 1074, 1078, 1080, 1081, 1086, 1084, 1087, 1092

SP10 R01

Revise the *2012 Standard Specifications* as follows:

**Page 10-1, Article 1000-1, DESCRIPTION, lines 9-10,** replace the last sentence of the first paragraph with the following:

Type IL, IP, IS or IT blended cement may be used instead of Portland cement.

**Page 10-1, Article 1000-1, DESCRIPTION, line 14,** add the following:

Use materials which do not produce a mottled appearance through rusting or other staining of the finished concrete surface.

**Page 10-1, Article 1000-2, MATERIALS, line 16,** add the following to the table of item references:

<b>Item</b>	<b>Section</b>
Type IL Blended Cement	1024-1

TABLE 1000-1 REQUIREMENTS FOR CONCRETE											
Class of Concrete	Min. Comp. Strength at 28 days	Maximum Water-Cement Ratio				Consistency Max. Slump		Cement Content			
		Air-Entrained Concrete		Non Air- Entrained Concrete		Vibrated	Non- Vibrated	Vibrated		Non- Vibrated	
		Rounded Aggregate	Angular Aggre- gate	Rounded Aggregate	Angular Aggre- gate			Min.	Max.	Min.	Max.
<i>Units</i>	<i>psi</i>					<i>inch</i>	<i>inch</i>	<i>lb/cy</i>	<i>lb/cy</i>	<i>lb/cy</i>	<i>lb/cy</i>
AA	4,500	0.381	0.426	-	-	3.5	-	639	715	-	-
AA Slip Form	4,500	0.381	0.426	-	-	1.5	-	639	715	-	-
Drilled Pier	4,500	-	-	0.450	0.450	-	5-7 dry 7-9 wet	-	-	640	800
A	3,000	0.488	0.532	0.550	0.594	3.5	4	564	-	602	-
B	2,500	0.488	0.567	0.559	0.630	2.5	4	508	-	545	-
B Slip Formed	2,500	0.488	0.567	-	-	1.5	-	508	-	-	-
Sand Light- weight	4,500	-	0.420	-	-	4	-	715	-	-	-
Latex Modified	3,000 7 day	0.400	0.400	-	-	6	-	658	-	-	-
Flowable Fill excavatable	150 max. at 56 days	as needed	as needed	as needed	as needed	-	Flow- able	-	-	40	100
Flowable Fill non-excavatable	125	as needed	as needed	as needed	as needed	-	Flow- able	-	-	100	as needed
Pavement	4,500 design, field  650 flexural, design only	0.559	0.559	-	-	1.5 slip form  3.0 hand place	-	526	-	-	-
Precast	See Table 1077-1	as needed	as needed	-	-	6	as needed	as needed	as needed	as needed	as needed
Prestress	per contract	See Table 1078-1	See Table 1078-1	-	-	8	-	564	as needed	-	-

Page 10-23, Table 1005-1, AGGREGATE GRADATION-COARSE AGGREGATE, replace with the following:

TABLE 1005-1 AGGREGATE GRADATION - COARSE AGGREGATE													
Percentage of Total by Weight Passing													
Std. Size #	2"	1 1/2"	1"	3/4"	1/2"	3/8"	#4	#8	#10	#16	#40	#200	Remarks
4	100	90-100	20-55	0-15	-	0-5	-	-	-	-	-	A	Asphalt Plant Mix
467M	100	95-100	-	35-70	-	0-30	0-5	-	-	-	-	A	Asphalt Plant Mix
5	-	100	90-100	20-55	0-10	0-5	-	-	-	-	-	A	AST, Sediment Control Stone
57	-	100	95-100	-	25-60	-	0-10	0-5	-	-	-	A	AST, Str. Concrete, Shoulder Drain, Sediment Control Stone
57M	-	100	95-100	-	25-45	-	0-10	0-5	-	-	-	A	AST, Concrete Pavement
6M	-	-	100	90-100	20-55	0-20	0-8	-	-	-	-	A	AST
67	-	-	100	90-100	-	20-55	0-10	0-5	-	-	-	A	AST, Str. Concrete, Asphalt Plant Mix
78M	-	-	-	100	98-100	75-100	20-45	0-15	-	-	-	A	Asphalt Plant Mix, Str. Conc, Weep Hole Drains
14M	-	-	-	-	-	100	35-70	5-20	-	0-8	-	A	Asphalt Plant Mix, AST, Weep Hole Drains, Str. Concrete
9	-	-	-	-	-	100	85-100	10-40	-	0-10	-	A	AST
ABC	-	100	75-97	-	55-80	-	35-55	-	25-45	-	14-30	4-12 <sup>B</sup>	Aggregate Base Course, Aggregate Stabilization
ABC (M)	-	100	75-100	-	45-79	-	20-40	-	0-25	-	-	0-12 <sup>B</sup>	Maintenance Stabilization
Light-weight C	-	-	-	-	100	80-100	5-40	0-20	-	0-10	-	0-2.5	AST

- A. See Subarticle 1005-4(A).
- B. See Subarticle 1005-4(B).
- C. For Lightweight Aggregate used in Structural Concrete, see Subarticle 1014-2(E)(6).

Page 10-46, Article 1024-1, PORTLAND CEMENT, line 33, add the following as the ninth paragraph:

Use Type IL blended cement that meets AASHTO M 240, except that the limestone content is limited to between 5 and 12% by weight and the constituents shall be interground. Class F fly ash can replace a portion of Type IL blended cement and shall be replaced as outlined in Subarticle 1000-4(I) for Portland cement. For mixes that contain cement with alkali content between 0.6% and 1.0% and for mixes that contain a reactive aggregate documented by the Department, use a pozzolan in the amount shown in Table 1024-1.



**Page 10-65, Article 1050-1, GENERAL, line 41**, replace the first sentence with the following:

All fencing material and accessories shall meet Section 106.

**Page 10-73, Article 1056-1 DESCRIPTION, lines 7-8**, delete the first sentence of the second paragraph and replace with the following:

Use geotextile fabrics that are on the NCDOT Approved Products List.

**Page 10-73, Article 1056-2 HANDLING AND STORING, line 17**, replace “mechanically stabilized earth (MSE) wall faces” with “temporary wall faces”.

**Page 10-74, TABLE 1056-1 GEOTEXTILE REQUIREMENTS**, replace table with the following:

<b>TABLE 1056-1 GEOTEXTILE REQUIREMENTS</b>						
<b>Property</b>	<b>Requirement (MARV<sup>A</sup>)</b>					<b>Test Method</b>
	<b>Type 1</b>	<b>Type 2</b>	<b>Type 3<sup>B</sup></b>	<b>Type 4</b>	<b>Type 5<sup>C</sup></b>	
<i>Typical Application</i>	<i>Shoulder Drains</i>	<i>Under Rip Rap</i>	<i>Temporary Silt Fence</i>	<i>Soil Stabilization</i>	<i>Temporary Walls</i>	
Elongation (MD & CD)	≥ 50%	≥ 50%	≤ 25%	< 50%	< 50%	ASTM D4632
Grab Strength (MD & CD)	Table 1 <sup>D</sup> , Class 3	Table 1 <sup>D</sup> , Class 1	100 lb	Table 1 <sup>D</sup> , Class 3	-	ASTM D4632
Tear Strength (MD & CD)			-		-	ASTM D4533
Puncture Strength			-		-	ASTM D6241
Ultimate Tensile Strength (MD & CD)	-	-	-	-	2,400 lb/ft (unless required otherwise in the contract)	ASTM D4595
Permittivity	Table 2 <sup>D</sup> , 15% to 50% <i>in Situ</i> Soil Passing No. 200 <sup>E</sup>		Table 7 <sup>D</sup>	Table 5 <sup>D</sup>	0.20 sec <sup>-1</sup>	ASTM D4491
Apparent Opening Size					No. 30 <sup>E</sup>	ASTM D4751
UV Stability (Retained Strength)					70%	ASTM D4355

- A. MARV does not apply to elongation
- B. Minimum roll width of 36" required
- C. Minimum roll width of 13 ft required
- D. AASHTO M 288
- E. US Sieve No. per AASHTO M 92

**Page 10-115, Subarticle 1074-7(B), Gray Iron Castings, lines 10-11**, replace with the first two sentences with the following:

Supply gray iron castings meeting all facets of AASHTO M 306 excluding proof load. Proof load testing will only be required for new casting designs during the design process, and conformance to M306 loading (40,000 lbs.) will be required only when noted on the design documents.

Page 10-126, Table 1078-1, REQUIREMENTS FOR CONCRETE, replace with the following:

<b>TABLE 1078-1 REQUIREMENTS FOR CONCRETE</b>		
<b>Property</b>	<b>28 Day Design Compressive Strength 6,000 psi or less</b>	<b>28 Day Design Compressive Strength greater than 6,000 psi</b>
Maximum Water/Cementitious Material Ratio	0.45	0.40
Maximum Slump without HRWR	3.5"	3.5"
Maximum Slump with HRWR	8"	8"
Air Content (upon discharge into forms)	5 + 2%	5 + 2%

Page 10-151, Article 1080-4 Inspection and Sampling, lines 18-22, replace (B), (C) and (D) with the following:

- (B) At least 3 panels prepared as specified in 5.5.10 of AASHTO M 300, Bullet Hole Immersion Test.
- (C) At least 3 panels of 4"x6"x1/4" for the Elcometer Adhesion Pull Off Test, ASTM D4541.
- (D) A certified test report from an approved independent testing laboratory for the Salt Fog Resistance Test, Cyclic Weathering Resistance Test, and Bullet Hole Immersion Test as specified in AASHTO M 300.
- (E) A certified test report from an approved independent testing laboratory that the product has been tested for slip coefficient and meets AASHTO M253, Class B.

Page 10-161, Subarticle 1081-1(A) Classifications, lines 29-33, delete first 3 sentences of the description for Type 2 and replace with the following:

**Type 2** - A low-modulus, general-purpose adhesive used in epoxy mortar repairs. It may be used to patch spalled, cracked or broken concrete where vibration, shock or expansion and contraction are expected.

Page 10-162, Subarticle 1081-1(A) Classifications, lines 4-7, delete the second and third sentences of the description for Type 3A. Lines 16-22, delete Types 6A, 6B and 6C.

Page 10-162, Subarticle 1081-1(B) Requirements, lines 26-30, replace the second paragraph with the following:

For epoxy resin systems used for embedding dowel bars, threaded rods, rebar, anchor bolts and other fixtures in hardened concrete, the manufacturer shall submit test results showing that the bonding system will obtain 125% of the specified required yield strength of the fixture. Furnish certification that, for the particular bolt grade, diameter and embedment depth required, the anchor system will not fail by adhesive failure and that there is no movement of the anchor bolt. For certification and anchorage, use 3,000 psi as the minimum Portland cement concrete compressive strength used in this test. Use adhesives that meet Section 1081.

List the properties of the adhesive on the container and include density, minimum and maximum temperature application, setting time, shelf life, pot life, shear strength and compressive strength.

Page 10-163, Table 1081-1 Properties of Mixed Epoxy Resin Systems, replace table with the following:

Property	Type 1	Type 2	Type 3	Type 3A	Type 4A	Type 4B	Type 5
Viscosity-Poises at 77°F ± 2°F	Gel	10-30	25-75	Gel	40-150	40-150	1-6
Spindle No.	-	3	4	--	4	4	2
Speed (RPM)	-	20	20	--	10	10	50
Pot Life (Minutes)	20-50	30-60	20-50	5-50	40-80	40-80	20-60
Minimum Tensile Strength at 7 days (psi)	1,500	2,000	4,000	4,000	1,500	1,500	4,000
Tensile Elongation at 7 days (%)	30 min.	30 min.	2-5	2-5	5-15	5-15	2-5
Min. Compressive Strength of 2" mortar cubes at 24 hours	3,000 (Neat)	4,000-	6,000-	6,000 (Neat)	3,000	3,000	6,000
Min. Compressive Strength of 2" mortar cubes at 7 days	5,000 (Neat)	-	-	-	-	5,000	-
Maximum Water Absorption (%)	1.5	1.0	1.0	1.5	1.0	1.0	1.0
Min. Bond Strength Slant Shear Test at 14 days (psi)	1,500	1,500	2,000	2,000	1,500	1,500	1,500

Page 10-164, Subarticle 1081-1(E) Prequalification, lines 31-33, replace the second sentence of the first paragraph with the following:

Manufacturers choosing to supply material for Department jobs must submit an application through the Value Management Unit with the following information for each type and brand name:

Page 10-164, Subarticle 1081-1(E)(3), line 37, replace this subarticle with the following:

(3) Type of the material in accordance with Articles 1081-1 and 1081-4,

Page 10-165, Subarticle 1081-1(E)(6), line 1, in the first sentence of the first paragraph replace "AASHTO M 237" with "the specifications".

DE00085

**Page 10-165, Subarticle 1081-1(E) Prequalification, line 9-10,** delete the second sentence of the last paragraph.

**Page 10-165, Subarticle 1081-1(F) Acceptance, line 14,** in the first sentence of the first paragraph replace “Type 1” with “Type 3”.

**Page 10-169, Subarticle 1081-3(G) Anchor Bolt Adhesives,** delete this subarticle.

**Page 10-170, Article 1081-3 Hot Bitumen, line 9,** add the following at the end of Section 1081:

#### **1081-4 EPOXY RESIN ADHESIVE FOR BONDING TRAFFIC MARKINGS**

##### **(A) General**

This section covers epoxy resin adhesive for bonding traffic markers to pavement surfaces.

##### **(B) Classification**

The types of epoxies and their uses are as shown below:

**Type I** – Rapid Setting, High Viscosity, Epoxy Adhesive. This type of adhesive provides rapid adherence to traffic markers to the surface of pavement.

**Type II** – Standard Setting, High Viscosity, Epoxy Adhesive. This type of adhesive is recommended for adherence of traffic markers to pavement surfaces when rapid set is not required.

**Type III** – Rapid Setting, Low Viscosity, Water Resistant, Epoxy Adhesive. This type of rapid setting adhesive, due to its low viscosity, is appropriate only for use with embedded traffic markers.

**Type IV** – Standard Set Epoxy for Blade Deflecting-Type Plowable Markers.

##### **(C) Requirements**

Epoxies shall conform to the requirements set forth in AASHTO M 237.

##### **(D) Prequalification**

Refer to Subarticle 1081-1(E).

##### **(E) Acceptance**

Refer to Subarticle 1081-1(F).

**Page 10-173, Article 1084-2 STEEL SHEET PILES, lines 37-38,** replace first paragraph with the following:

Steel sheet piles detailed for permanent applications shall be hot rolled and meet ASTM A572 or ASTM A690 unless otherwise required by the plans. Steel sheet piles shall be coated as required by the plans. Galvanized sheet piles shall be coated in accordance with Section 1076. Metallized sheet piles shall be metallized in accordance to the Project Special Provision “Thermal Sprayed Coatings (Metallization)” with an 8 mil, 99.9% aluminum alloy coating and a 0.5 mil seal coating. Any portion of the metallized sheet piling encased in concrete shall receive a barrier coat. The barrier coat shall be an approved waterborne coating with a low-viscosity which readily absorbs into the pores of the aluminum thermal sprayed coating. The waterborne coating shall be applied at a spreading rate that results in a theoretical 1.5 mil dry film thickness. The manufacturer shall issue a letter of certification that the resin chemistry of the waterborne coating is compatible with the 99.9% aluminum thermal sprayed alloy and suitable for tidal water applications.

**Page 10-174, Subarticle 1086-1(B)(1) Epoxy, lines 18-24,** replace this subarticle with the following:

The epoxy shall meet Article 1081-4.

The 2 types of epoxy adhesive which may be used are Type I, Rapid Setting, and Type II, Standard Setting. Use Type II when the pavement temperature is above 60°F or per the manufacturer’s recommendations whichever is more stringent. Use Type I when the pavement temperature is between 50°F and 60°F or per the manufacturer’s recommendations whichever is more stringent. Epoxy adhesive Type I, Cold Set, may be used to attach temporary pavement markers to the pavement surface when the pavement temperature is between 32°F and 50°F or per the manufacturer’s recommendations whichever is more stringent.

**Page 10-175, Subarticle 1086-2(E) Epoxy Adhesives, line 27**, replace “Section 1081” with “Article 1081-4”.

**Page 10-177, Subarticle 1086-3(E) Epoxy Adhesives, line 22**, replace “Section 1081” with “Article 1081-4”.

**Page 10-179, Subarticle 1087-4(A) Composition, lines 39-41**, replace the third paragraph with the following:

All intermixed and drop-on glass beads shall not contain more than 75 ppm arsenic or 200 ppm lead.

**Page 10-180, Subarticle 1087-4(B) Physical Characteristics, line 8**, replace the second paragraph with the following:

All intermixed and drop-on glass beads shall comply with NCGS § 136-30.2 and 23 USC § 109(r).

**Page 10-181, Subarticle 1087-7(A) Intermixed and Drop-on Glass Beads, line 24**, add the following after the first paragraph:

Use X-ray Fluorescence for the normal sampling procedure for intermixed and drop-on beads, without crushing, to check for any levels of arsenic and lead. If any arsenic or lead is detected, the sample shall be crushed and repeat the test using X-ray Fluorescence. If the X-ray Fluorescence test shows more than a LOD of 5 ppm, test the beads using United States Environmental Protection Agency Method 6010B, 6010C or 3052 for no more than 75 ppm arsenic or 200 ppm lead.

**Page 10-204, Subarticle 1092-2(A) Performance and Test Requirements**, replace **Table 1092-3 Minimum Coefficient of Retroreflection for NC Grade A** with the following:

<b>TABLE 1092-3</b> <b>MINIMUM COEFFICIENT OF RETROREFLECTION FOR NC GRADE A</b> <b>(Candelas Per Lux Per Square Meter)</b>								
<b>Observation Angle, degrees</b>	<b>Entrance Angle, degrees</b>	<b>White</b>	<b>Yellow</b>	<b>Green</b>	<b>Red</b>	<b>Blue</b>	<b>Fluorescent Yellow Green</b>	<b>Fluorescent Yellow</b>
0.2	-4.0	525	395	52	95	30	420	315
0.2	30.0	215	162	22	43	10	170	130
0.5	-4.0	310	230	31	56	18	245	185
0.5	30.0	135	100	14	27	6	110	81
1.0	-4.0	<b>120</b>	60	8	16	3.6	64	48
1.0	30.0	45	34	4.5	9	2	36	27

# PROJECT SPECIAL PROVISIONS

## CONSTRUCTION METHODS

The contractor shall perform all construction activities in accordance with the applicable requirements of the NCDOT Standard Specifications for Roads and Structures dated January 2012, except as otherwise specified herein.

Wherever reference is made in the Specifications to information shown in the plans, such information will be furnished by the Engineer.

### SITE INVESTIGATION AND REPRESENTATION

The Contractor acknowledges that he has satisfied himself as to the nature of the work, and general and local conditions; particularly those bearing on transportation, availability of labor, State Regulations for safety and security of property, roads, and facilities required for the prosecution of the work and all matters which can in any way affect the work or cost thereof under this contract. Any failure by the Contractor to acquaint himself with all the available information concerning these conditions does not relieve him from the responsibility for estimating properly the difficulty of and cost of successfully performing the work.

### CONTROL OF EROSION, SILT AND POLLUTION

Control of erosion, siltation and pollution shall meet the requirements of section 107-12 of the Standard Specifications for Roads and Structures dated January, 2012 and as shown on the plans.

The Contractor may, at his option, submit an alternate plan and sequence by submitting 3 copies of the proposed alternate to the Engineer for approval. Approval must be obtained before construction is started on the alternate plan.

In the event the erosion and sedimentation control plan is not followed or properly maintained, all other work shall be suspended until corrections are made.

The Contractor shall exercise every reasonable precaution throughout the life of the project to prevent erosion and siltation.

### MINORITY BUSINESS ENTERPRISE AND WOMEN BUSINESS ENTERPRISE (DIVISIONS)

(10-16-07)(Rev. 12-17-13)

102-15(J)

SP1 G67

#### Description

The purpose of this Special Provision is to carry out the North Carolina Department of Transportation's policy of ensuring nondiscrimination in the award and administration of contracts financed in whole or in part with State funds.

#### Definitions

*Additional MBE/WBE Subcontractors* - Any MBE/WBE submitted at the time of bid that will not be used to meet either the MBE or WBE goal. No submittal of a Letter of Intent is required.

*Committed MBE/WBE Subcontractor* - Any MBE/WBE submitted at the time of bid that is being used to meet either the MBE or WBE goal by submission of a Letter of Intent. Or any MBE or WBE used as a replacement for a previously committed MBE or WBE firm.

*Contract Goals Requirement* - The approved MBE and WBE participation at time of award, but not greater than the advertised contract goals for each.

*Goal Confirmation Letter* - Written documentation from the Department to the bidder confirming the Contractor's approved, committed MBE and WBE participation along with a listing of the committed MBE and WBE firms.

*Manufacturer* - A firm that operates or maintains a factory or establishment that produces on the premises, the materials or supplies obtained by the Contractor.

## DE00085

*MBE Goal* - A portion of the total contract, expressed as a percentage, that is to be performed by committed MBE subcontractor(s).

*Minority Business Enterprise (MBE)* - A firm certified as a Disadvantaged Minority-Owned Business Enterprise through the North Carolina Unified Certification Program.

*Regular Dealer* - A firm that owns, operates, or maintains a store, warehouse, or other establishment in which the materials or supplies required for the performance of the contract are bought, kept in stock, and regularly sold to the public in the usual course of business. A regular dealer engages in, as its principal business and in its own name, the purchase and sale or lease of the products in question. A regular dealer in such bulk items as steel, cement, gravel, stone, and petroleum products need not keep such products in stock, if it owns and operates distribution equipment for the products. Brokers and packagers are not regarded as manufacturers or regular dealers within the meaning of this section.

*North Carolina Unified Certification Program (NCUCP)* - A program that provides comprehensive services and information to applicants for MBE/WBE certification. The MBE/WBE program follows the same regulations as the federal Disadvantaged Business Enterprise (DBE) program in accordance with 49 CFR Part 26.

*United States Department of Transportation (USDOT)* - Federal agency responsible for issuing regulations (49 CFR Part 26) and official guidance for the DBE program.

*WBE Goal* - A portion of the total contract, expressed as a percentage, that is to be performed by committed WBE subcontractor(s).

*Women Business Enterprise (WBE)* - A firm certified as a Disadvantaged Women-Owned Business Enterprise through the North Carolina Unified Certification Program.

### **Forms and Websites Referenced in this Provision**

*Payment Tracking System* - On-line system in which the Contractor enters the payments made to MBE and WBE subcontractors who have performed work on the project. <https://apps.dot.state.nc.us/Vendor/PaymentTracking/>

*DBE-IS Subcontractor Payment Information* - Form for reporting the payments made to all MBE/WBE firms working on the project. This form is for paper bid projects only. <http://www.ncdot.org/doh/forms/files/DBE-IS.xls>

*RF-1 MBE/WBE Replacement Request Form* - Form for replacing a committed MBE or WBE.  
<http://connect.ncdot.gov/projects/construction/Construction%20Forms/DBE%20MBE%20WBE%20Replacement%20Request%20Form.pdf>

*SAF Subcontract Approval Form* - Form required for approval to sublet the contract.  
<http://connect.ncdot.gov/projects/construction/Construction%20Forms/Subcontract%20Approval%20Form%20Rev.%202012.zip>

*JC-1 Joint Check Notification Form* - Form and procedures for joint check notification. The form acts as a written joint check agreement among the parties providing full and prompt disclosure of the expected use of joint checks.  
<http://connect.ncdot.gov/projects/construction/Construction%20Forms/Joint%20Check%20Notification%20Form.pdf>

*Letter of Intent* - Form signed by the Contractor and the MBE/WBE subcontractor, manufacturer or regular dealer that affirms that a portion of said contract is going to be performed by the signed MBE/WBE for the amount listed at the time of bid.  
<http://connect.ncdot.gov/letting/LetCentral/Letter%20of%20Intent%20to%20Perform%20as%20a%20Subcontractor.pdf>

*Listing of MBE and WBE Subcontractors Form* - Form for entering MBE/WBE subcontractors on a project that will meet this MBE and WBE goals. This form is for paper bids only.  
[http://connect.ncdot.gov/municipalities/Bid%20Proposals%20for%20LGA%20Content/09%20MBE-WBE%20Subcontractors%20\(State\).doc](http://connect.ncdot.gov/municipalities/Bid%20Proposals%20for%20LGA%20Content/09%20MBE-WBE%20Subcontractors%20(State).doc)

*Subcontractor Quote Comparison Sheet* - Spreadsheet for showing all subcontractor quotes in the work areas where MBEs and WBEs quoted on the project. This sheet is submitted with good faith effort packages.  
<http://connect.ncdot.gov/business/SmallBusiness/Documents/DBE%20Subcontractor%20Quote%20Comparison%20Example.xls>

**MBE and WBE Goal**

The following goals for participation by Minority Business Enterprises and Women Business Enterprises are established for this contract:

- (A) Minority Business Enterprises **3 %**
  - (1) *If the MBE goal is more than zero*, the Contractor shall exercise all necessary and reasonable steps to ensure that MBEs participate in at least the percent of the contract as set forth above as the MBE goal.
  - (2) *If the MBE goal is zero*, the Contractor shall make an effort to recruit and use MBEs during the performance of the contract. Any MBE participation obtained shall be reported to the Department.
- (B) Women Business Enterprises **4 %**
  - (1) *If the WBE goal is more than zero*, the Contractor shall exercise all necessary and reasonable steps to ensure that WBEs participate in at least the percent of the contract as set forth above as the WBE goal.
  - (2) *If the WBE goal is zero*, the Contractor shall make an effort to recruit and use WBEs during the performance of the contract. Any WBE participation obtained shall be reported to the Department.

**Directory of Transportation Firms (Directory)**

Real-time information is available about firms doing business with the Department and firms that are certified through NCUCP in the Directory of Transportation Firms. Only firms identified in the Directory as MBE and WBE certified shall be used to meet the MBE and WBE goals respectively. The Directory can be found at the following link. <https://partner.ncdot.gov/VendorDirectory/default.html>

The listing of an individual firm in the directory shall not be construed as an endorsement of the firm’s capability to perform certain work.

**Listing of MBE/WBE Subcontractors**

At the time of bid, bidders shall submit all MBE and WBE participation that they anticipate to use during the life of the contract. Only those identified to meet the MBE goal and the WBE goal will be considered committed, even though the listing shall include both committed MBE/WBE subcontractors and additional MBE/WBE subcontractors. Any additional MBE/WBE subcontractor participation submitted at the time of bid will be used toward overall race-neutral goals. Only those firms with current MBE and WBE certification at the time of bid opening will be acceptable for listing in the bidder’s submittal of MBE and WBE participation. The Contractor shall indicate the following required information:

- (A) *If either the MBE or WBE goal is more than zero*,
  - (1) Bidders, at the time the bid proposal is submitted, shall submit a listing of MBE/WBE participation, including the names and addresses on *Listing of MBE and WBE Subcontractors* contained elsewhere in the contract documents in order for the bid to be considered responsive. Bidders shall indicate the total dollar value of the MBE and WBE participation for the contract.



**DE00085**

- (2) If bidders have no MBE or WBE participation, they shall indicate this on the *Listing of MBE and WBE Subcontractors* by entering the word “None” or the number “0.” This form shall be completed in its entirety. **Blank forms will not be deemed to represent zero participation.** Bids submitted that do not have MBE and WBE participation indicated on the appropriate form will not be read publicly during the opening of bids. The Department will not consider these bids for award and the proposal will be rejected.
  - (3) The bidder shall be responsible for ensuring that the MBE/WBE is certified at the time of bid by checking the Directory of Transportation Firms. If the firm is not certified at the time of the bid-letting, that MBE’s or WBE’s participation will not count towards achieving the corresponding goal.
- (B) *If either the MBE or WBE goal is zero, entries on the Listing of MBE and WBE Subcontractors are not required for the zero goal, however any MBE or WBE participation that is achieved during the project shall be reported in accordance with requirements contained elsewhere in the special provision.*

**MBE or WBE Prime Contractor**

When a certified MBE or WBE firm bids on a contract that contains MBE and WBE goals, the firm is responsible for meeting the goals or making good faith efforts to meet the goals, just like any other bidder. In most cases, a MBE or WBE bidder on a contract will meet one of the goals by virtue of the work it performs on the contract with its own forces. However, all the work that is performed by the MBE or WBE bidder and any other similarly certified subcontractors will count toward the goal. The MBE or WBE bidder shall list itself along with any MBE or WBE subcontractors, if any, in order to receive credit toward the goals.

For example, on a proposed contract, the WBE goal is 10%, and the MBE goal is 8%. A WBE bidder puts in a bid where they will perform 40% of the contract work and have a WBE subcontractor which will perform another 5% of the work. Together the two WBE firms submit on the *Listing of MBE and WBE Subcontractors* a value of 45% of the contract which fulfills the WBE goal. The 8% MBE goal shall be obtained through MBE participation with MBE certified subcontractors or documented through a good faith effort. It should be noted that you cannot combine the two goals to meet an overall value. The two goals shall remain separate.

MBE/WBE prime contractors shall also follow Sections A or B listed under *Listing of MBE/WBE Subcontractors* just as a non-MBE/WBE bidder would.

**Written Documentation – Letter of Intent**

The bidder shall submit written documentation for each MBE/WBE that will be used to meet the MBE and WBE goals of the contract, indicating the bidder’s commitment to use the MBE/WBE in the contract. This documentation shall be submitted on the Department’s form titled *Letter of Intent*.

The documentation shall be received in the office of the Engineer no later than 12:00 noon of the sixth calendar day following opening of bids, unless the sixth day falls on Saturday, Sunday or an official state holiday. In that situation, it is due in the office of the Engineer no later than 12:00 noon on the next official state business day.

If the bidder fails to submit the Letter of Intent from each committed MBE and WBE to be used toward the MBE and WBE goals, or if the form is incomplete (i.e. both signatures are not present), the MBE/WBE participation will not count toward meeting the MBE/WBE goal. If the lack of this participation drops the commitment below either the MBE or WBE goal, the Contractor shall submit evidence of good faith efforts for the goal not met, completed in its entirety, to the Engineer no later than 12:00 noon of the eighth calendar day following opening of bids, unless the eighth day falls on Saturday, Sunday or an official state holiday. In that situation, it is due in the office of the Engineer no later than 12:00 noon on the next official state business day.

**Submission of Good Faith Effort**

If the bidder fails to meet or exceed either the MBE or the WBE goal, the apparent lowest responsive bidder shall submit to the Department documentation of adequate good faith efforts made to reach that specific goal(s).

## DE00085

One complete set and nine copies of this information shall be received in the office of the Engineer no later than 12:00 noon of the sixth calendar day following opening of bids, unless the sixth day falls on Saturday, Sunday or an official state holiday. In that situation, it is due in the office of the Engineer no later than 12:00 noon on the next official state business day.

Note: Where the information submitted includes repetitious solicitation letters, it will be acceptable to submit a representative letter along with a distribution list of the firms that were solicited. Documentation of MBE/WBE quotations shall be a part of the good faith effort submittal. This documentation may include written subcontractor quotations, telephone log notations of verbal quotations, or other types of quotation documentation.

### **Consideration of Good Faith Effort for Projects with MBE/WBE Goals More Than Zero**

Adequate good faith efforts mean that the bidder took all necessary and reasonable steps to achieve the goal which, by their scope, intensity, and appropriateness, could reasonably be expected to obtain sufficient MBE/WBE participation. Adequate good faith efforts also mean that the bidder actively and aggressively sought MBE/WBE participation. Mere *pro forma* efforts are not considered good faith efforts.

The Department will consider the quality, quantity, and intensity of the different kinds of efforts a bidder has made. Listed below are examples of the types of actions a bidder will take in making a good faith effort to meet the goals and are not intended to be exclusive or exhaustive, nor is it intended to be a mandatory checklist.

- (A) Soliciting through all reasonable and available means (e.g. attendance at pre-bid meetings, advertising, written notices, use of verifiable electronic means through the use of the NCDOT Directory of Transportation Firms) the interest of all certified MBEs/WBEs who have the capability to perform the work of the contract. The bidder must solicit this interest within at least 10 days prior to bid opening to allow the MBEs/WBEs to respond to the solicitation. Solicitation shall provide the opportunity to MBEs/WBEs within the Division and surrounding Divisions where the project is located. The bidder must determine with certainty if the MBEs/WBEs are interested by taking appropriate steps to follow up initial solicitations.
- (B) Selecting portions of the work to be performed by MBEs/WBEs in order to increase the likelihood that the MBE and WBE goals will be achieved.
  - (1) Where appropriate, break out contract work items into economically feasible units to facilitate MBE/WBE participation, even when the prime contractor might otherwise prefer to perform these work items with its own forces.
  - (2) Negotiate with subcontractors to assume part of the responsibility to meet the contract MBE/WBE goals when the work to be sublet includes potential for MBE/WBE participation (2<sup>nd</sup> and 3<sup>rd</sup> tier subcontractors).
- (C) Providing interested MBEs/WBEs with adequate information about the plans, specifications, and requirements of the contract in a timely manner to assist them in responding to a solicitation.
- (D)
  - (1) Negotiating in good faith with interested MBEs/WBEs. It is the bidder's responsibility to make a portion of the work available to MBE/WBE subcontractors and suppliers and to select those portions of the work or material needs consistent with the available MBE/WBE subcontractors and suppliers, so as to facilitate MBE/WBE participation. Evidence of such negotiation includes the names, addresses, and telephone numbers of MBEs/WBEs that were considered; a description of the information provided regarding the plans and specifications for the work selected for subcontracting; and evidence as to why additional agreements could not be reached for MBEs/WBEs to perform the work.
  - (2) A bidder using good business judgment would consider a number of factors in negotiating with subcontractors, including MBE/WBE subcontractors, and would take a firm's price and capabilities as well as contract goals into consideration. However, the fact that there may be some additional costs involved in finding and using MBEs/WBEs is not in itself sufficient reason for a bidder's failure to meet the contract MBE or WBE goals, as long as such costs are reasonable.

Also, the ability or desire of a prime contractor to perform the work of a contract with its own organization does not relieve the bidder of the responsibility to make good faith efforts. Bidding contractors are not, however, required to accept higher quotes from MBEs/WBEs if the price difference is excessive or unreasonable.

- (E) Not rejecting MBEs/WBEs as being unqualified without sound reasons based on a thorough investigation of their capabilities. The bidder's standing within its industry, membership in specific groups, organizations, or associates and political or social affiliations (for example, union vs. non-union employee status) are not legitimate causes for the rejection or non-solicitation of bids in the bidder's efforts to meet the project goal.
- (F) Making efforts to assist interested MBEs/WBEs in obtaining bonding, lines of credit, or insurance as required by the recipient or bidder.
- (G) Making efforts to assist interested MBEs/WBEs in obtaining necessary equipment, supplies, materials, or related assistance or services.
- (H) Effectively using the services of available minority/women community organizations; minority/women contractors' groups; Federal, State, and local minority/women business assistance offices; and other organizations as allowed on a case-by-case basis to provide assistance in the recruitment and placement of MBEs/WBEs. Contact within 7 days from the bid opening NCDOT's Business Development Manager in the Business Opportunity and Work Force Development Unit to give notification of the bidder's inability to get MBE or WBE quotes.
- (I) Any other evidence that the bidder submits which shows that the bidder has made reasonable good faith efforts to meet the MBE and WBE goal.

In addition, the Department may take into account the following:

- (1) Whether the bidder's documentation reflects a clear and realistic plan for achieving the MBE and WBE goals.
- (2) The bidders' past performance in meeting the MBE and WBE goals.
- (3) The performance of other bidders in meeting the MBE and WBE goals. For example, when the apparent successful bidder fails to meet the goals, but others meet it, you may reasonably raise the question of whether, with additional reasonable efforts the apparent successful bidder could have met the goals. If the apparent successful bidder fails to meet the MBE and WBE goals, but meets or exceeds the average MBE and WBE participation obtained by other bidders, the Department may view this, in conjunction with other factors, as evidence of the apparent successful bidder having made a good faith effort.

If the Department does not award the contract to the apparent lowest responsive bidder, the Department reserves the right to award the contract to the next lowest responsive bidder that can satisfy to the Department that the MBE and WBE goals can be met or that an adequate good faith effort has been made to meet the MBE and WBE goals.

### **Non-Good Faith Appeal**

The Engineer will notify the contractor verbally and in writing of non-good faith. A contractor may appeal a determination of non-good faith made by the Goal Compliance Committee. If a contractor wishes to appeal the determination made by the Committee, they shall provide written notification to the Engineer. The appeal shall be made within 2 business days of notification of the determination of non-good faith.

**Counting MBE/WBE Participation Toward Meeting MBE/WBE Goals**

## (A) Participation

The total dollar value of the participation by a committed MBE/WBE will be counted toward the contract goal requirements. The total dollar value of participation by a committed MBE/WBE will be based upon the value of work actually performed by the MBE/WBE and the actual payments to MBE/WBE firms by the Contractor.

## (B) Joint Checks

Prior notification of joint check use shall be required when counting MBE/WBE participation for services or purchases that involves the use of a joint check. Notification shall be through submission of Form JC-1 (*Joint Check Notification Form*) and the use of joint checks shall be in accordance with the Department's Joint Check Procedures.

## (C) Subcontracts (Non-Trucking)

A MBE/WBE may enter into subcontracts. Work that a MBE subcontracts to another MBE firm may be counted toward the MBE contract goal requirement. The same holds for work that a WBE subcontracts to another WBE firm. Work that a MBE subcontracts to a non-MBE firm does not count toward the MBE contract goal requirement. Again, the same holds true for the work that a WBE subcontracts to a non-WBE firm. If a MBE or WBE contractor or subcontractor subcontracts a significantly greater portion of the work of the contract than would be expected on the basis of standard industry practices, it shall be presumed that the MBE or WBE is not performing a commercially useful function. The MBE/WBE may present evidence to rebut this presumption to the Department. The Department's decision on the rebuttal of this presumption may be subject to review by the Office of Inspector General, NCDOT.

## (D) Joint Venture

When a MBE or WBE performs as a participant in a joint venture, the Contractor may count toward its contract goal requirement a portion of the total value of participation with the MBE or WBE in the joint venture, that portion of the total dollar value being a distinct clearly defined portion of work that the MBE or WBE performs with its forces.

## (E) Suppliers

A contractor may count toward its MBE or WBE requirement 60 percent of its expenditures for materials and supplies required to complete the contract and obtained from a MBE or WBE regular dealer and 100 percent of such expenditures from a MBE or WBE manufacturer.

## (F) Manufacturers and Regular Dealers

A contractor may count toward its MBE or WBE requirement the following expenditures to MBE/WBE firms that are not manufacturers or regular dealers:

- (1) The fees or commissions charged by a MBE/WBE firm for providing a *bona fide* service, such as professional, technical, consultant, or managerial services, or for providing bonds or insurance specifically required for the performance of a DOT-assisted contract, provided the fees or commissions are determined to be reasonable and not excessive as compared with fees and commissions customarily allowed for similar services.
- (2) With respect to materials or supplies purchased from a MBE/WBE, which is neither a manufacturer nor a regular dealer, count the entire amount of fees or commissions charged for assistance in the procurement of the materials and supplies, or fees or transportation charges for the delivery of materials or supplies required on a job site (but not the cost of the materials and supplies themselves), provided the fees are determined to be reasonable and not excessive as compared with fees customarily allowed for similar services.

**Commercially Useful Function****(A) MBE/WBE Utilization**

The Contractor may count toward its contract goal requirement only expenditures to MBEs and WBEs that perform a commercially useful function in the work of a contract. A MBE/WBE performs a commercially useful function when it is responsible for execution of the work of the contract and is carrying out its responsibilities by actually performing, managing, and supervising the work involved. To perform a commercially useful function, the MBE/WBE shall also be responsible with respect to materials and supplies used on the contract, for negotiating price, determining quality and quantity, ordering the material and installing (where applicable) and paying for the material itself. To determine whether a MBE/WBE is performing a commercially useful function, the Department will evaluate the amount of work subcontracted, industry practices, whether the amount the firm is to be paid under the contract is commensurate with the work it is actually performing and the MBE/WBE credit claimed for its performance of the work, and any other relevant factors.

**(B) MBE/WBE Utilization in Trucking**

The following factors will be used to determine if a MBE or WBE trucking firm is performing a commercially useful function:

- (1) The MBE/WBE shall be responsible for the management and supervision of the entire trucking operation for which it is responsible on a particular contract, and there shall not be a contrived arrangement for the purpose of meeting the MBE or WBE goal.
- (2) The MBE/WBE shall itself own and operate at least one fully licensed, insured, and operational truck used on the contract.
- (3) The MBE/WBE receives credit for the total value of the transportation services it provides on the contract using trucks it owns, insures, and operates using drivers it employs.
- (4) The MBE may subcontract the work to another MBE firm, including an owner-operator who is certified as a MBE. The same holds true that a WBE may subcontract the work to another WBE firm, including an owner-operator who is certified as a WBE. When this occurs, the MBE or WBE who subcontracts work receives credit for the total value of the transportation services the subcontracted MBE or WBE provides on the contract. It should be noted that every effort shall be made by MBE and WBE contractors to subcontract to the same certification (i.e., MBEs to MBEs and WBEs to WBEs), in order to fulfill the goal requirement. This, however, may not always be possible due to the limitation of firms in the area. If the MBE or WBE firm shows a good faith effort has been made to reach out to similarly certified transportation service providers and there is no interest or availability, and they can get assistance from other certified providers, the Engineer will not hold the prime liable for meeting the goal.
- (5) The MBE/WBE may also subcontract the work to a non-MBE/WBE firm, including from an owner-operator. The MBE/WBE who subcontracts the work to a non-MBE/WBE is entitled to credit for the total value of transportation services provided by the non-MBE/WBE subcontractor not to exceed the value of transportation services provided by MBE/WBE-owned trucks on the contract. Additional participation by non-MBE/WBE subcontractors receives credit only for the fee or commission it receives as a result of the subcontract arrangement. The value of services performed under subcontract agreements between the MBE/WBE and the Contractor will not count towards the MBE/WBE contract requirement.
- (6) A MBE/WBE may lease truck(s) from an established equipment leasing business open to the general public. The lease must indicate that the MBE/WBE has exclusive use of and control over the truck. This requirement does not preclude the leased truck from working for others during the term of the lease with the consent of the MBE/WBE, so long as the lease gives the MBE/WBE

absolute priority for use of the leased truck. This type of lease may count toward the MBE/WBE's credit as long as the driver is under the MBE/WBE's payroll.

- (7) Subcontracted/leased trucks shall display clearly on the dashboard the name of the MBE/WBE that they are subcontracted/leased to and their own company name if it is not identified on the truck itself. Magnetic door signs are not permitted.

### **MBE/WBE Replacement**

When a Contractor has relied on a commitment to a MBE or WBE firm (or an approved substitute MBE or WBE firm) to meet all or part of a contract goal requirement, the contractor shall not terminate the MBE/WBE for convenience. This includes, but is not limited to, instances in which the Contractor seeks to perform the work of the terminated subcontractor with another MBE/WBE subcontractor, a non-MBE/WBE subcontractor, or with the Contractor's own forces or those of an affiliate. A MBE/WBE may only be terminated after receiving the Engineer's written approval based upon a finding of good cause for the termination.

All requests for replacement of a committed MBE/WBE firm shall be submitted to the Engineer for approval on Form RF-1 (*Replacement Request*). If the Contractor fails to follow this procedure, the Contractor may be disqualified from further bidding for a period of up to 6 months.

The Contractor shall comply with the following for replacement of a committed MBE/WBE:

#### **(A) Performance Related Replacement**

When a committed MBE is terminated for good cause as stated above, an additional MBE that was submitted at the time of bid may be used to fulfill the MBE commitment. The same holds true if a committed WBE is terminated for good cause, an additional WBE that was submitted at the time of bid may be used to fulfill the WBE goal. A good faith effort will only be required for removing a committed MBE/WBE if there were no additional MBEs/WBEs submitted at the time of bid to cover the same amount of work as the MBE/WBE that was terminated.

If a replacement MBE/WBE is not found that can perform at least the same amount of work as the terminated MBE/WBE, the Contractor shall submit a good faith effort documenting the steps taken. Such documentation shall include, but not be limited to, the following:

- (1) Copies of written notification to MBEs/WBEs that their interest is solicited in contracting the work defaulted by the previous MBE/WBE or in subcontracting other items of work in the contract.
- (2) Efforts to negotiate with MBEs/WBEs for specific subbids including, at a minimum:
  - (a) The names, addresses, and telephone numbers of MBEs/WBEs who were contacted.
  - (b) A description of the information provided to MBEs/WBEs regarding the plans and specifications for portions of the work to be performed.
- (3) A list of reasons why MBE/WBE quotes were not accepted.
- (4) Efforts made to assist the MBEs/WBEs contacted, if needed, in obtaining bonding or insurance required by the Contractor.

#### **(B) Decertification Replacement**

- (1) When a committed MBE/WBE is decertified by the Department after the SAF (*Subcontract Approval Form*) has been received by the Department, the Department will not require the Contractor to solicit replacement MBE/WBE participation equal to the remaining work to be performed by the decertified firm. The participation equal to the remaining work performed by the decertified firm will count toward the contract goal requirement.

**DE00085**

- (2) When a committed MBE/WBE is decertified prior to the Department receiving the SAF (*Subcontract Approval Form*) for the named MBE/WBE firm, the Contractor shall take all necessary and reasonable steps to replace the MBE/WBE subcontractor with another similarly certified MBE/WBE subcontractor to perform at least the same amount of work to meet the MBE/WBE goal requirement. If a MBE/WBE firm is not found to do the same amount of work, a good faith effort must be submitted to NCDOT (see A herein for required documentation).

**Changes in the Work**

When the Engineer makes changes that result in the reduction or elimination of work to be performed by a committed MBE/WBE, the Contractor will not be required to seek additional participation. When the Engineer makes changes that result in additional work to be performed by a MBE/WBE based upon the Contractor's commitment, the MBE/WBE shall participate in additional work to the same extent as the MBE/WBE participated in the original contract work.

When the Engineer makes changes that result in extra work, which has more than a minimal impact on the contract amount, the Contractor shall seek additional participation by MBEs/WBEs unless otherwise approved by the Engineer.

When the Engineer makes changes that result in an alteration of plans or details of construction, and a portion or all of the work had been expected to be performed by a committed MBE/WBE, the Contractor shall seek participation by MBEs/WBEs unless otherwise approved by the Engineer.

When the Contractor requests changes in the work that result in the reduction or elimination of work that the Contractor committed to be performed by a MBE/WBE, the Contractor shall seek additional participation by MBEs/WBEs equal to the reduced MBE/WBE participation caused by the changes.

**Reports and Documentation**

A SAF (*Subcontract Approval Form*) shall be submitted for all work which is to be performed by a MBE/WBE subcontractor. The Department reserves the right to require copies of actual subcontract agreements involving MBE/WBE subcontractors.

When using transportation services to meet the contract commitment, the Contractor shall submit a proposed trucking plan in addition to the SAF. The plan shall be submitted prior to beginning construction on the project. The plan shall include the names of all trucking firms proposed for use, their certification type(s), the number of trucks owned by the firm, as well as the individual truck identification numbers, and the line item(s) being performed.

Within 30 calendar days of entering into an agreement with a MBE/WBE for materials, supplies or services, not otherwise documented by the SAF as specified above, the Contractor shall furnish the Engineer a copy of the agreement. The documentation shall also indicate the percentage (60% or 100%) of expenditures claimed for MBE/WBE credit.

**Reporting Minority and Women Business Enterprise Participation**

The Contractor shall provide the Engineer with an accounting of payments made to all MBE and WBE firms, including material suppliers and contractors at all levels (prime, subcontractor, or second tier subcontractor). This accounting shall be furnished to the Engineer for any given month by the end of the following month. Failure to submit this information accordingly may result in the following action:

- (A) Withholding of money due in the next partial pay estimate; or
- (B) Removal of an approved contractor from the prequalified bidders' list or the removal of other entities from the approved subcontractors list.

**DE00085**

While each contractor (prime, subcontractor, 2nd tier subcontractor) is responsible for accurate accounting of payments to MBEs/WBEs, it shall be the prime contractor’s responsibility to report all monthly and final payment information in the correct reporting manner.

Failure on the part of the Contractor to submit the required information in the time frame specified may result in the disqualification of that contractor and any affiliate companies from further bidding until the required information is submitted.

Failure on the part of any subcontractor to submit the required information in the time frame specified may result in the disqualification of that contractor and any affiliate companies from being approved for further work on future projects until the required information is submitted.

Contractors reporting transportation services provided by non-MBE/WBE lessees shall evaluate the value of services provided during the month of the reporting period only.

At any time, the Engineer can request written verification of subcontractor payments.

The Contractor shall report the accounting of payments on the Department’s DBE-IS (*Subcontractor Payment Information*) with each invoice. Invoices will not be processed for payment until the DBE-IS is received.

**Failure to Meet Contract Requirements**

Failure to meet contract requirements in accordance with Subarticle 102-15(J) of the *2012 Standard Specifications* may be cause to disqualify the Contractor.

**PROSECUTION AND PROGRESS**

The Contractor shall pursue the work diligently with workmen in sufficient numbers, abilities, and supervision, and with equipment, materials, and methods of construction as may be required to complete the work described in the contract by the completion date and in accordance with Section 108 of the Standard Specifications.

**PROGRESS SCHEDULE**

The Contractor shall provide a progress schedule in accordance with Section 108-2 of the Standard Specifications.

**DRIVEWAYS AND PRIVATE PROPERTY**

The Contractor shall maintain access to driveways for all residents and property owners throughout the life of the project.

The Contractor shall not perform work for private citizens or agencies in conjunction with this project or within the project limits of this contract. Any driveway paved by a Contractor which ties into a NCDOT system road being paved by the Contractor must be paved either prior to the road paving project or after its completion.

**SHOULDER AND FILL SLOPE MATERIAL**

(5-21-02)

235, 560

SP2 R45 A

**Description**

Perform the required shoulder and slope construction for this project in accordance with the applicable requirements of Section 560 and Section 235 of the *2012 Standard Specifications*.

**Measurement and Payment**

Where the material has been obtained from an authorized stockpile or from a borrow source and *Borrow Excavation* is not included in the contract, no direct payment will be made for this work, as the cost of this work will be part of the work being paid at the contract lump sum price for *Grading*. If *Borrow Excavation* is included in this contract and the material has been obtained from an authorized stockpile or from a borrow source, measurement and payment will be as provided in Section 230 of the *2012 Standard Specifications* for *Borrow Excavation*.



**SUBSURFACE INFORMATION**

(7-1-95)

450

SP1 G112 C

Subsurface information is available on the structure portion of this project only.

**NO MAJOR CONTRACT ITEMS**

(2-19-02) (Rev. 8-21-07)

104

SP1 G31

None of the items included in this contract will be major items.

**NO SPECIALTY ITEMS**

(7-1-95)

108-6

SP1 G34

None of the items included in this contract will be specialty items (see Article 108-6 of the *2012 Standard Specifications*).

**PLANT AND PEST QUARANTINES****(Imported Fire Ant, Gypsy Moth, Witchweed, And Other Noxious Weeds)**

(3-18-03) (Rev. 10-15-13)

Z-04a

**Within Quarantined Area**

This project may be within a county regulated for plant and/or pests. If the project or any part of the Contractor's operations is located within a quarantined area, thoroughly clean all equipment prior to moving out of the quarantined area. Comply with federal/state regulations by obtaining a certificate or limited permit for any regulated article moving from the quarantined area.

**Originating in a Quarantined County**

Obtain a certificate or limited permit issued by the N.C. Department of Agriculture/United States Department of Agriculture. Have the certificate or limited permit accompany the article when it arrives at the project site.

**Contact**

Contact the N.C. Department of Agriculture/United States Department of Agriculture at 1-800-206-9333, 919-733-6932, or <http://www.ncagr.gov/plantind/> to determine those specific project sites located in the quarantined area or for any regulated article used on this project originating in a quarantined county.

**Regulated Articles Include**

1. Soil, sand, gravel, compost, peat, humus, muck, and decomposed manure, separately or with other articles. This includes movement of articles listed above that may be associated with cut/waste, ditch pulling, and shoulder cutting.
2. Plants with roots including grass sod.
3. Plant crowns and roots.
4. Bulbs, corms, rhizomes, and tubers of ornamental plants.
5. Hay, straw, fodder, and plant litter of any kind.
6. Clearing and grubbing debris.
7. Used agricultural cultivating and harvesting equipment.
8. Used earth-moving equipment.
9. Any other products, articles, or means of conveyance, of any character, if determined by an inspector to present a hazard of spreading imported fire ant, gypsy moth, witchweed or other noxious weeds.

**CLEARING AND GRUBBING - METHOD III**

(4-6-06) (Rev. 1-17-12)

200

SP2 R02B

Perform clearing on this project to the limits established by Method "III" shown on Standard Drawing No. 200.03 of the *2012 Roadway Standard Drawings*.

**PIPE INSTALLATION**

(11-20-12)

300

SP3 R01

Revise the *2012 Standard Specifications* as follows:

**Page 3-1, Article 300-2, Materials**, line 23-24, replace sentence with:

Provide foundation conditioning geotextile in accordance with Section 1056 for Type 4 geotextile.

**BRIDGE APPROACH FILLS**

(10-19-10) (Rev. 1-17-12)

422

SP4 R02

**Description**

Bridge approach fills include bridge approach fills for sub regional tier bridges and reinforced bridge approach fills. Construct bridge approach fills in accordance with the contract and Standard Drawing No. 422.10 or 422.11 of the *2012 Roadway Standard Drawings*. Define "geosynthetics" as geotextiles or geomembranes.

**Materials**

Refer to Division 10 of the *2012 Standard Specifications*.

<b>Item</b>	<b>Section</b>
Anchor Pins	1056-2
Geotextiles	1056
Portland Cement Concrete	1000
Select Material	1016
Subsurface Drainage Materials	1044
Wire Staples	1060-8(D)

For bridge approach fills for sub regional tier bridges, provide Type 1 geotextile for filtration geotextiles. For reinforced bridge approach fills, provide Type 5 geotextile for geotextile reinforcement and Type 1 geotextile and No. 78M stone for drains. Use Class B concrete for concrete pads.

Use Class III or V select material for reinforced bridge approach fills and only Class V select material (standard size No. 78M stone) for bridge approach fills for sub regional tier bridges. Provide PVC pipes, fittings and outlet pipes for subsurface drainage materials. For drains and PVC pipes behind end bents, use pipes with perforations that meet AASHTO M 278.

Use PVC, HDPE or linear low density polyethylene (LLDPE) geomembranes for reinforced bridge approach fills. For PVC geomembranes, provide grade PVC30 geomembranes that meet ASTM D7176. For HDPE and LLDPE geomembranes, use geomembranes with a nominal thickness of at least 30 mils that meet Geosynthetic Research Institute Standard Specifications GM13 or GM17, respectively. Handle and store geomembranes in accordance with Article 1056-2 of the *2012 Standard Specifications*. Provide material certifications for geomembranes in accordance with Article 1056-3 of the *2012 Standard Specifications*.

**Construction Methods**

Excavate as necessary for bridge approach fills in accordance with the contract. Notify the Engineer when foundation excavation is complete. Do not place geomembranes or filtration geotextiles until excavation dimensions and foundation material are approved. Attach geomembranes and filtration geotextiles to end bent cap back and wing walls with adhesives, tapes or other approved methods. Glue or weld geomembrane seams to prevent leakage.

For reinforced bridge approach fills, place geotextile reinforcement within 3" of locations shown in Standard Drawing No. 422.10 of the *2012 Roadway Standard Drawings* and in slight tension free of kinks, folds, wrinkles or creases. Install geotextile reinforcement with the orientation, dimensions and number of layers shown in Standard Drawing No. 422.10 of the *2012 Roadway Standard Drawings*. Place first layer of geotextile reinforcement directly on geomembranes with no void or material in between. Install geotextile reinforcement with the machine direction (MD) parallel to the roadway centerline. The MD is the direction of the length or long dimension of the geotextile roll. Do not splice or overlap geotextile reinforcement in the MD so seams are perpendicular to the roadway centerline. Wrap geotextile reinforcement at end bent cap back and wing walls as shown in Standard Drawing No. 422.10 of the *2012 Roadway Standard Drawings* and directed by the Engineer. Extend geotextile reinforcement at least 4 ft back behind end bent cap back and wing walls into select material.

Overlap adjacent geotextiles at least 18" with seams oriented parallel to the roadway centerline. Hold geotextiles in place with wire staples or anchor pins as needed. Contact the Engineer when existing or future obstructions such as foundations, pavements, pipes, inlets or utilities will interfere with geosynthetics.

For reinforced bridge approach fills, construct one foot square drains consisting of 4" diameter continuous perforated PVC pipes surrounded by No. 78M stone wrapped in Type 1 geotextiles. Install drains in accordance with Standard Drawing No. 422.10 of the *2012 Roadway Standard Drawings*. For bridge approach fills for sub regional tier bridges, install 4" diameter continuous perforated PVC drain pipes in accordance with Standard Drawing No. 422.11 of the *2012 Roadway Standard Drawings*.

Use solvent cement to connect PVC pipes so joints do not leak. Connect perforated pipes to outlet pipes just behind wing walls. Provide drain pipes and drains with positive drainage towards outlets. Place pipe sleeves in or under wing walls for outlet pipes so positive drainage is maintained. Use sleeves that can withstand wing wall loads.

Place select material in 8" to 10" thick lifts. Use only hand operated compaction equipment to compact select material for bridge approach fills. Compact Class III select material in accordance with Subarticle 235-3(C) of the *2012 Standard Specifications*. Compact No. 78M stone with a vibratory compactor to the satisfaction of the Engineer. Do not displace or damage geosynthetics, drain pipes or drains when placing and compacting select material. End dumping directly on geosynthetics is not permitted. Do not operate heavy equipment on geosynthetics, drain pipes or drains until they are covered with at least 8" of select material. Replace any damaged geosynthetics, drain pipes or drains to the satisfaction of the Engineer.

Cover open ends of outlet pipes with rodent screens as shown in Standard Drawing No. 815.03 of the *2012 Roadway Standard Drawings*. Connect ends of outlet pipes to concrete pads or existing drainage structures as directed by the Engineer. Construct concrete pads with an Ordinary surface finish that meets Subarticle 825-6(B) of the *2012 Standard Specifications*.

**Measurement and Payment**

*Reinforced Bridge Approach Fill, Station \_\_\_\_* will be paid at the contract lump sum price. The contract lump sum price for *Reinforced Bridge Approach Fill, Station \_\_\_\_* will be full compensation for labor, tools, equipment and reinforced bridge approach fill materials, excavating, backfilling, hauling and removing excavated materials, compacting select material, connecting outlet pipes to existing drainage structures and supplying select materials, geosynthetics, drains, pipe sleeves and outlet components and any incidentals necessary to construct all reinforced bridge approach fills at each bridge.

*Bridge Approach Fill - Sub Regional Tier, Station \_\_\_\_* will be paid at the contract lump sum price. The contract lump sum price for *Bridge Approach Fill - Sub Regional Tier, Station \_\_\_\_* will be full compensation for labor, tools, equipment and bridge approach fill materials, excavating, backfilling, hauling and removing excavated

**DE00085**

materials, compacting No. 78M stone, connecting outlet pipes to existing drainage structures and supplying No. 78M stone, filtration geotextiles, drain pipes, pipe sleeves and outlet components and any incidentals necessary to construct all bridge approach fills at each sub regional tier bridge.

Payment will be made under:

<b>Pay Item</b>	<b>Pay Unit</b>
Reinforced Bridge Approach Fill, Station _____	Lump Sum
Bridge Approach Fill - Sub Regional Tier, Station _____	Lump Sum

**ASPHALT PAVEMENTS - SUPERPAVE**

(6-19-12) (Rev. 2-18-14)

605, 609, 610, 650, 660

SP6 R01

Revise the 2012 Standard Specifications as follows:

**Page 6-3, Article 605-7 APPLICATION RATES AND TEMPERATURES**, replace this article, including Table 601-1, with the following:

Apply tack coat uniformly across the existing surface at target application rates shown in Table 605-1.

<b>TABLE 605-1 APPLICATION RATES FOR TACK COAT</b>	
<b>Existing Surface</b>	<b>Target Rate (gal/sy)</b>
	<b>Emulsified Asphalt</b>
New Asphalt	0.04 ± 0.01
Oxidized or Milled Asphalt	0.06 ± 0.01
Concrete	0.08 ± 0.01

Apply tack coat at a temperature within the ranges shown in Table 605-2. Tack coat shall not be overheated during storage, transport or at application.

<b>TABLE 605-2 APPLICATION TEMPERATURE FOR TACK COAT</b>	
<b>Asphalt Material</b>	<b>Temperature Range</b>
Asphalt Binder, Grade PG 64-22	350 - 400°F
Emulsified Asphalt, Grade RS-1H	130 - 160°F
Emulsified Asphalt, Grade CRS-1	130 - 160°F
Emulsified Asphalt, Grade CRS-1H	130 - 160°F
Emulsified Asphalt, Grade HFMS-1	130 - 160°F
Emulsified Asphalt, Grade CRS-2	130 - 160°F

**Page 6-7, Article 609-3 FIELD VERIFICATION OF MIXTURE AND JOB MIX FORMULA ADJUSTMENTS**, lines 35-37, delete the second sentence of the second paragraph.

**Page 6-18, Article 610-1 DESCRIPTION**, lines 40-41, delete the last sentence of the last paragraph.

**Page 6-19, Subarticle 610-3(A) Mix Design-General**, line 5, add the following as the first paragraph:

Warm mix asphalt (WMA) is allowed for use at the Contractor’s option in accordance with the NCDOT Approved Products List for WMA Technologies available at:

**<https://connect.ncdot.gov/resources/Materials/MaterialsResources/Warm%20Mix%20Asphalt%20Approved%20List.pdf>**

**Page 6-21, Subarticle 610-3(C) Job Mix Formula (JMF)**, replace Table 610-1 with the following:

<b>Binder Grade</b>	<b>HMA JMF Temperature</b>	<b>WMA JMF Temperature Range</b>
PG 64-22	300°F	225 - 275°F
PG 70-22	315°F	240 - 290°F
PG 76-22	335°F	260 - 310°F

- A.** The mix temperature, when checked in the truck at the roadway, shall be within plus 15° and minus 25° of the temperature specified on the JMF.

**Page 6-21, Subarticle 610-3(C) Job Mix Formula (JMF)**, lines 4-6, delete first sentence of the second paragraph. Line 7, in the second sentence of the second paragraph, replace “275°F” with “275°F or greater.”

**Page 6-22, Article 610-4 WEATHER, TEMPERATURE AND SEASONAL LIMITATIONS FOR PRODUCING AND PLACING ASPHALT MIXTURES**, lines 15-17, replace the second sentence of the first paragraph with the following:

Do not place asphalt material when the air or surface temperatures, measured at the location of the paving operation away from artificial heat, do not meet Table 610-5.

**Page 6-23, Article 610-4 WEATHER, TEMPERATURE AND SEASONAL LIMITATIONS FOR PRODUCING AND PLACING ASPHALT MIXTURES**, replace Table 610-5 with the following:

<b>Asphalt Concrete Mix Type</b>	<b>Minimum Surface and Air Temperature</b>
B25.0B, C	35°F
I19.0B, C, D	35°F
SF9.5A, S9.5B	40°F
S9.5C, S12.5C	45°F
S9.5D, S12.5D	50°F

**Page 6-26, Article 610-7 HAULING OF ASPHALT MIXTURE**, lines 22-23, in the fourth sentence of the first paragraph replace “so as to overlap the top of the truck bed and” with “to”.

**Page 6-41, Subarticle 650-3(B) Mix Design Criteria**, replace Table 650-1 with the following:

<b>Grading Requirements</b>	<b>Total Percent Passing</b>		
<i>Sieve Size (mm)</i>	<i>Type FC-1</i>	<i>Type FC-1 Modified</i>	<i>Type FC-2 Modified</i>
19.0	-	-	100
12.5	100	100	<b>80</b> - 100
9.50	75 - 100	75 - 100	55 - <b>80</b>
4.75	25 - 45	25 - 45	15 - <b>30</b>
2.36	5 - 15	5 - 15	5 - <b>15</b>
0.075	1.0 - 3.0	1.0 - 3.0	2.0 - 4.0

**Page 6-50, Table 660-1 MATERIAL APPLICATION RATES AND TEMPERATURES**, lines 1-2, replace Note A in Table 660-1 with the following:

- A.** Use No. 6M, No. 67, No. 5 and No. 78M aggregate for retreatment before an asphalt overlay on existing pavement based on the width of the cracks in the existing pavement. Choose No. 78M for sections of roadway where the average width of existing cracks is 1/4" or less in width, No. 67 for sections of roadway

**DE00085**

where the average width of existing cracks are 1/4" to 5/8" in width and choose No. 5 for sections of roadway where the existing crack widths are greater than 5/8".

**ASPHALT BINDER CONTENT OF ASPHALT PLANT MIXES**

(11-21-00) (Rev. 7-17-12)

609

SP6 R15

The approximate asphalt binder content of the asphalt concrete plant mixtures used on this project will be as follows:

Asphalt Concrete Base Course	Type B 25.0__	4.4%
Asphalt Concrete Intermediate Course	Type I 19.0__	4.8%
Asphalt Concrete Surface Course	Type S 4.75A	6.8%
Asphalt Concrete Surface Course	Type SA-1	6.8%
Asphalt Concrete Surface Course	Type SF 9.5A	6.7%
Asphalt Concrete Surface Course	Type S 9.5__	6.0%
Asphalt Concrete Surface Course	Type S 12.5__	5.6%

The actual asphalt binder content will be established during construction by the Engineer within the limits established in the *2012 Standard Specifications*.

**FUEL PRICE ADJUSTMENT**

(11-15-05) (Rev. 2-18-14)

109-8

SP1 G43

Revise the *2012 Standard Specifications* as follows:

**Page 1-83, Article 109-8, Fuel Price Adjustments**, add the following:

The base index price for DIESEL #2 FUEL is \$ **3.1476** per gallon. Where any of the following are included as pay items in the contract, they will be eligible for fuel price adjustment.

The pay items and the fuel factor used in calculating adjustments to be made will be as follows:

<b>Description</b>	<b>Units</b>	<b>Fuel Usage Factor Diesel</b>
Unclassified Excavation	Gal/CY	0.29
Borrow Excavation	Gal/CY	0.29
Class IV Subgrade Stabilization	Gal/Ton	0.55
Aggregate Base Course	Gal/Ton	0.55
Sub-Ballast	Gal/Ton	0.55
Asphalt Concrete Base Course, Type ____	Gal/Ton	2.90
Asphalt Concrete Intermediate Course, Type ____	Gal/Ton	2.90
Asphalt Concrete Surface Course, Type ____	Gal/Ton	2.90
Open-Graded Asphalt Friction Course	Gal/Ton	2.90
Permeable Asphalt Drainage Course, Type ____	Gal/Ton	2.90
Sand Asphalt Surface Course, Type ____	Gal/Ton	2.90
Aggregate for Cement Treated Base Course	Gal/Ton	0.55
Portland Cement for Cement Treated Base Course	Gal/Ton	0.55
" " Portland Cement Concrete Pavement	Gal/SY	0.245
Concrete Shoulders Adjacent to ____ " Pavement	Gal/SY	0.245

**PRICE ADJUSTMENT - ASPHALT BINDER FOR PLANT MIX**

(11-21-00)

SP6 R25

Price adjustments for asphalt binder for plant mix will be made in accordance with Section 620 of the *2012 Standard Specifications*.

The base price index for asphalt binder for plant mix is \$558.21 per ton.

DE00085

This base price index represents an average of F.O.B. selling prices of asphalt binder at supplier's terminals on March 1, 2014.

**GUARDRAIL ANCHOR UNITS, TYPE 350**

(4-20-04) (Rev. 8-16-11)

862

SP8 R65

**Description**

Furnish and install guardrail anchor units in accordance with the details in the plans, the applicable requirements of Section 862 of the *2012 Standard Specifications*, and at locations shown in the plans.

**Materials**

The Contractor may at his option, furnish any one of the guardrail anchor units or approved equal.

Guardrail anchor unit (ET-Plus) as manufactured by:

Trinity Industries, Inc.  
2525 N. Stemmons Freeway  
Dallas, Texas 75207  
Telephone: 800-644-7976

The guardrail anchor unit (SKT 350) as manufactured by:

Road Systems, Inc.  
3616 Old Howard County Airport  
Big Spring, Texas 79720  
Telephone: 915-263-2435

Prior to installation the Contractor shall submit to the Engineer:

- (A) FHWA acceptance letter for each guardrail anchor unit certifying it meets the requirements of NCHRP Report 350, Test Level 3, in accordance with Article 106-2 of the *2012 Standard Specifications*.
- (B) Certified working drawings and assembling instructions from the manufacturer for each guardrail anchor unit in accordance with Article 105-2 of the *2012 Standard Specifications*.

No modifications shall be made to the guardrail anchor unit without the express written permission from the manufacturer. Perform installation in accordance with the details in the plans, and details and assembling instructions furnished by the manufacturer.

**Construction Methods**

Guardrail end delineation is required on all approach and trailing end sections for both temporary and permanent installations. Guardrail end delineation consists of yellow reflective sheeting applied to the entire end section of the guardrail in accordance with Article 1088-3 of the *2012 Standard Specifications* and is incidental to the cost of the guardrail anchor unit.

**Measurement and Payment**

Measurement and payment will be made in accordance with Article 862-6 of the *2012 Standard Specifications*.

Payment will be made under:

**Pay Item**  
Guardrail Anchor Units, Type 350

**Pay Unit**  
Each

## REMOVAL OF EXISTING PAVEMENT MARKERS

The Contractor's attention is directed to the fact that there may be pavement markers on this project. The Contractor will be required to remove and dispose of these markers prior to the paving operation.

No direct payment will be made for this work, as it will be incidental to the paving operation and payment at the contract unit price for the various asphalt items in the contract will be full compensation for such work.

### **ROADWAY STANDARD DRAWINGS FOR PAVEMENT MARKINGS AND MARKERS**

(01-17-12)

RWZ-5

Use the following in conjunction with the *2012 Standard Specifications*:

#### **Standard Pavement Markings**

*2012 Roadway Standard Drawings:*

1205.01, 1205.02, 1205.03, 1205.04, 1205.05,  
1205.06, 1205.07, 1205.08, 1205.09, 1205.10,  
1205.11, 1205.12, 1205.13

#### **Raised Pavement Markers**

*2012 Roadway Standard Drawings:*

1205.12, 1250.01, 1251.01

#### **Snowplowable Pavement Markers**

*2012 Roadway Standard Drawings:*

1250.01, 1253.01

#### **Milled Rumble Strips**

*2012 Roadway Standard Drawings:*

665.01

## **EROSION AND SEDIMENT CONTROL/STORMWATER CERTIFICATION**

(1-16-07) (Rev 9-18-12)

105-16, 225-2, 16

SP1 G180

### **General**

Schedule and conduct construction activities in a manner that will minimize soil erosion and the resulting sedimentation and turbidity of surface waters. Comply with the requirements herein regardless of whether or not a National Pollution discharge Elimination System (NPDES) permit for the work is required.

Establish a chain of responsibility for operations and subcontractors' operations to ensure that the *Erosion and Sediment Control/Stormwater Pollution Prevention Plan* is implemented and maintained over the life of the contract.

- (A) *Certified Supervisor* - Provide a certified Erosion and Sediment Control/Stormwater Supervisor to manage the Contractor and subcontractor operations, insure compliance with Federal, State and Local ordinances and regulations, and manage the Quality Control Program.
- (B) *Certified Foreman* - Provide a certified, trained foreman for each construction operation that increases the potential for soil erosion or the possible sedimentation and turbidity of surface waters.
- (C) *Certified Installer* - Provide a certified installer to install or direct the installation for erosion or sediment/stormwater control practices.
- (D) *Certified Designer* - Provide a certified designer for the design of the erosion and sediment control/stormwater component of reclamation plans and, if applicable, for the design of the project erosion and sediment control/stormwater plan.

### **Roles and Responsibilities**

- (A) *Certified Erosion and Sediment Control/Stormwater Supervisor* - The Certified Supervisor shall be Level II and responsible for ensuring the erosion and sediment control/stormwater plan is adequately implemented and maintained on the project and for conducting the quality control program. The Certified



Supervisor shall be on the project within 24 hours notice from initial exposure of an erodible surface to the project's final acceptance. Perform the following duties:

- (1) Manage Operations - Coordinate and schedule the work of subcontractors so that erosion and sediment control/stormwater measures are fully executed for each operation and in a timely manner over the duration of the contract.
  - (a) Oversee the work of subcontractors so that appropriate erosion and sediment control/stormwater preventive measures are conformed to at each stage of the work.
  - (b) Prepare the required National Pollutant Discharge Elimination System (NPDES) Inspection Record and submit to the Engineer.
  - (c) Attend all weekly or monthly construction meetings to discuss the findings of the NPDES inspection and other related issues.
  - (d) Implement the erosion and sediment control/stormwater site plans requested.
  - (e) Provide any needed erosion and sediment control/stormwater practices for the Contractor's temporary work not shown on the plans, such as, but not limited to work platforms, temporary construction, pumping operations, plant and storage yards, and cofferdams.
  - (f) Acquire applicable permits and comply with requirements for borrow pits, dewatering, and any temporary work conducted by the Contractor in jurisdictional areas.
  - (g) Conduct all erosion and sediment control/stormwater work in a timely and workmanlike manner.
  - (h) Fully perform and install erosion and sediment control/stormwater work prior to any suspension of the work.
  - (i) Coordinate with Department, Federal, State and Local Regulatory agencies on resolution of erosion and sediment control/stormwater issues due to the Contractor's operations.
  - (j) Ensure that proper cleanup occurs from vehicle tracking on paved surfaces or any location where sediment leaves the Right-of-Way.
  - (k) Have available a set of erosion and sediment control/stormwater plans that are initialed and include the installation date of Best Management Practices. These practices shall include temporary and permanent groundcover and be properly updated to reflect necessary plan and field changes for use and review by Department personnel as well as regulatory agencies.
  
- (2) Requirements set forth under the NPDES Permit - The Department's NPDES Stormwater permit (NCS000250) outlines certain objectives and management measures pertaining to construction activities. The permit references *NCG010000, General Permit to Discharge Stormwater* under the NPDES, and states that the Department shall incorporate the applicable requirements into its delegated Erosion and Sediment Control Program for construction activities disturbing one or more acres of land. The Department further incorporates these requirements on all contracted bridge and culvert work at jurisdictional waters, regardless of size. Some of the requirements are, but are not limited to:
  - (a) Control project site waste to prevent contamination of surface or ground waters of the state, i.e. from equipment operation/maintenance, construction materials, concrete washout, chemicals, litter, fuels, lubricants, coolants, hydraulic fluids, any other petroleum products, and sanitary waste.
  - (b) Inspect erosion and sediment control/stormwater devices and stormwater discharge outfalls at least once every 7 calendar days, twice weekly for construction related *Federal Clean Water Act, Section 303(d)* impaired streams with turbidity violations, and within 24 hours after a significant rainfall event of 0.5 inch that occurs within a 24 hour period.
  - (c) Maintain an onsite rain gauge or use the Department's Multi-Sensor Precipitation Estimate website to maintain a daily record of rainfall amounts and dates.
  - (d) Maintain erosion and sediment control/stormwater inspection records for review by Department and Regulatory personnel upon request.
  - (e) Implement approved reclamation plans on all borrow pits, waste sites and staging areas.

- (f) Maintain a log of turbidity test results as outlined in the Department's Procedure for Monitoring Borrow Pit Discharge.
  - (g) Provide secondary containment for bulk storage of liquid materials.
  - (h) Provide training for employees concerning general erosion and sediment control/stormwater awareness, the Department's NPDES Stormwater Permit NCS000250 requirements, and the applicable requirements of the *General Permit, NCG010000*.
  - (i) Report violations of the NPDES permit to the Engineer immediately who will notify the Division of Water Quality Regional Office within 24 hours of becoming aware of the violation.
- (3) Quality Control Program - Maintain a quality control program to control erosion, prevent sedimentation and follow provisions/conditions of permits. The quality control program shall:
- (a) Follow permit requirements related to the Contractor and subcontractors' construction activities.
  - (b) Ensure that all operators and subcontractors on site have the proper erosion and sediment control/stormwater certification.
  - (c) Notify the Engineer when the required certified erosion and sediment control/stormwater personnel are not available on the job site when needed.
  - (d) Conduct the inspections required by the NPDES permit.
  - (e) Take corrective actions in the proper timeframe as required by the NPDES permit for problem areas identified during the NPDES inspections.
  - (f) Incorporate erosion control into the work in a timely manner and stabilize disturbed areas with mulch/seed or vegetative cover on a section-by-section basis.
  - (g) Use flocculants approved by state regulatory authorities where appropriate and where required for turbidity and sedimentation reduction.
  - (h) Ensure proper installation and maintenance of temporary erosion and sediment control devices.
  - (i) Remove temporary erosion or sediment control devices when they are no longer necessary as agreed upon by the Engineer.
  - (j) The Contractor's quality control and inspection procedures shall be subject to review by the Engineer. Maintain NPDES inspection records and make records available at all times for verification by the Engineer.
- (B) *Certified Foreman* - At least one Certified Foreman shall be onsite for each type of work listed herein during the respective construction activities to control erosion, prevent sedimentation and follow permit provisions:
- (1) Foreman in charge of grading activities
  - (2) Foreman in charge of bridge or culvert construction over jurisdictional areas
  - (3) Foreman in charge of utility activities
- The Contractor may request to use the same person as the Level II Supervisor and Level II Foreman. This person shall be onsite whenever construction activities as described above are taking place. This request shall be approved by the Engineer prior to work beginning.
- The Contractor may request to name a single Level II Foreman to oversee multiple construction activities on small bridge or culvert replacement projects. This request shall be approved by the Engineer prior to work beginning.
- (C) *Certified Installers* - Provide at least one onsite, Level I Certified Installer for each of the following erosion and sediment control/stormwater crew:
- (1) Seeding and Mulching
  - (2) Temporary Seeding
  - (3) Temporary Mulching
  - (4) Sodding
  - (5) Silt fence or other perimeter erosion/sediment control device installations

## DE00085

- (6) Erosion control blanket installation
- (7) Hydraulic tackifier installation
- (8) Turbidity curtain installation
- (9) Rock ditch check/sediment dam installation
- (10) Ditch liner/matting installation
- (11) Inlet protection
- (12) Riprap placement
- (13) Stormwater BMP installations (such as but not limited to level spreaders, retention/detention devices)
- (14) Pipe installations within jurisdictional areas

If a Level I *Certified Installer* is not onsite, the Contractor may substitute a Level II Foreman for a Level I Installer, provided the Level II Foreman is not tasked to another crew requiring Level II Foreman oversight.

- (D) *Certified Designer* - Include the certification number of the Level III-B Certified Designer on the erosion and sediment control/stormwater component of all reclamation plans and if applicable, the certification number of the Level III-A Certified Designer on the design of the project erosion and sediment control/stormwater plan.

### **Preconstruction Meeting**

Furnish the names of the *Certified Erosion and Sediment Control/Stormwater Supervisor*, *Certified Foremen*, *Certified Installers* and *Certified Designer* and notify the Engineer of changes in certified personnel over the life of the contract within 2 days of change.

### **Ethical Responsibility**

Any company performing work for the North Carolina Department of Transportation has the ethical responsibility to fully disclose any reprimand or dismissal of an employee resulting from improper testing or falsification of records.

### **Revocation or Suspension of Certification**

Upon recommendation of the Chief Engineer to the certification entity, certification for *Supervisor*, *Certified Foremen*, *Certified Installers* and *Certified Designer* may be revoked or suspended with the issuance of an *Immediate Corrective Action (ICA)*, *Notice of Violation (NOV)*, or *Cease and Desist Order* for erosion and sediment control/stormwater related issues.

The Chief Engineer may recommend suspension or permanent revocation of certification due to the following:

- (A) Failure to adequately perform the duties as defined within this certification provision.
- (B) Issuance of an ICA, NOV, or Cease and Desist Order.
- (C) Failure to fully perform environmental commitments as detailed within the permit conditions and specifications.
- (D) Demonstration of erroneous documentation or reporting techniques.
- (E) Cheating or copying another candidate's work on an examination.
- (F) Intentional falsification of records.
- (G) Directing a subordinate under direct or indirect supervision to perform any of the above actions.
- (H) Dismissal from a company for any of the above reasons.
- (I) Suspension or revocation of one's certification by another entity.

Suspension or revocation of a certification will be sent by certified mail to the certificant and the Corporate Head of the company that employs the certificant.

A certificant has the right to appeal any adverse action which results in suspension or permanent revocation of certification by responding, in writing, to the Chief Engineer within 10 calendar days after receiving notice of the proposed adverse action.

Chief Engineer  
 1536 Mail Service Center  
 Raleigh, NC 27699-1536

Failure to appeal within 10 calendar days will result in the proposed adverse action becoming effective on the date specified on the certified notice. Failure to appeal within the time specified will result in a waiver of all future appeal rights regarding the adverse action taken. The certificant will not be allowed to perform duties associated with the certification during the appeal process.

The Chief Engineer will hear the appeal and make a decision within 7 days of hearing the appeal. Decision of the Chief Engineer will be final and will be made in writing to the certificant.

If a certification is temporarily suspended, the certificant shall pass any applicable written examination and any proficiency examination, at the conclusion of the specified suspension period, prior to having the certification reinstated.

### Measurement and Payment

*Certified Erosion and Sediment Control/Stormwater Supervisor, Certified Foremen, Certified Installers and Certified Designer* will be incidental to the project for which no direct compensation will be made.

### PROCEDURE FOR MONITORING BORROW PIT DISCHARGE

(2-20-07) (Rev. 3-20-13)

105-16, 230, 801

SP1 G181

Water discharge from borrow pit sites shall not cause surface waters to exceed 50 NTUs (nephelometric turbidity unit) in streams not designated as trout waters and 10 NTUs in streams, lakes or reservoirs designated as trout waters. For lakes and reservoirs not designated as trout waters, the turbidity shall not exceed 25 NTUs. If the turbidity exceeds these levels due to natural background conditions, the existing turbidity level shall not be increased.

If during any operating day, the downstream water quality exceeds the standard, the Contractor shall do all of the following:

- (A) Either cease discharge or modify the discharge volume or turbidity levels to bring the downstream turbidity levels into compliance, or
- (B) Evaluate the upstream conditions to determine if the exceedance of the standard is due to natural background conditions. If the background turbidity measurements exceed the standard, operation of the pit and discharge can continue as long as the stream turbidity levels are not increased due to the discharge.
- (C) Measure and record the turbidity test results (time, date and sampler) at all defined sampling locations 30 minutes after startup and at a minimum, one additional sampling of all sampling locations during that 24-hour period in which the borrow pit is discharging.
- (D) Notify DWQ within 24 hours of any stream turbidity standard exceedances that are not brought into compliance.

During the Environmental Assessment required by Article 230-4 of the *2012 Standard Specifications*, the Contractor shall define the point at which the discharge enters into the State's surface waters and the appropriate sampling locations. Sampling locations shall include points upstream and downstream from the point at which the discharge enters these waters. Upstream sampling location shall be located so that it is not influenced by backwater conditions and represents natural background conditions. Downstream sampling location shall be located at the point where complete mixing of the discharge and receiving water has occurred.

The discharge shall be closely monitored when water from the dewatering activities is introduced into jurisdictional wetlands. Any time visible sedimentation (deposition of sediment) on the wetland surface is observed, the dewatering activity will be suspended until turbidity levels in the stilling basin can be reduced to a level where sediment deposition does not occur. Staining of wetland surfaces from suspended clay particles, occurring after

**DE00085**

evaporation or infiltration, does not constitute sedimentation. No activities shall occur in wetlands that adversely affect the functioning of a wetland. Visible sedimentation will be considered an indication of possible adverse impacts on wetland use.

The Engineer will perform independent turbidity tests on a random basis. These results will be maintained in a log within the project records. Records will include, at a minimum, turbidity test results, time, date and name of sampler. Should the Department’s test results exceed those of the Contractor’s test results, an immediate test shall be performed jointly with the results superseding the previous test results of both the Department and the Contractor.

The Contractor shall use the *NCDOT Turbidity Reduction Options for Borrow Pits Matrix*, available at [http://www.ncdot.gov/doh/operations/dp\\_chief\\_eng/roadside/fieldops/downloads/Files/TurbidityReductionOptionSheet.pdf](http://www.ncdot.gov/doh/operations/dp_chief_eng/roadside/fieldops/downloads/Files/TurbidityReductionOptionSheet.pdf) to plan, design, construct, and maintain BMPs to address water quality standards. Tier I Methods include stilling basins which are standard compensatory BMPs. Other Tier I methods are noncompensatory and shall be used when needed to meet the stream turbidity standards. Tier II Methods are also noncompensatory and are options that may be needed for protection of rare or unique resources or where special environmental conditions exist at the site which have led to additional requirements being placed in the DWQ’s 401 Certifications and approval letters, Isolated Wetland Permits, Riparian Buffer Authorization or a DOT Reclamation Plan’s Environmental Assessment for the specific site. Should the Contractor exhaust all Tier I Methods on a site exclusive of rare or unique resources or special environmental conditions, Tier II Methods may be required by regulators on a case by case basis per supplemental agreement.

The Contractor may use cation exchange capacity (CEC) values from proposed site borings to plan and develop the bid for the project. CEC values exceeding 15 milliequivalents per 100 grams of soil may indicate a high potential for turbidity and should be avoided when dewatering into surface water is proposed.

No additional compensation for monitoring borrow pit discharge will be paid.

**LAWN TYPE APPEARANCE**

All areas adjacent to lawns must be hand finished as directed to give a lawn type appearance. Remove all trash, debris, and stones ¾" and larger in diameter or other obstructions that could interfere with providing a smooth lawn type appearance. These areas shall be reseeded to match their original vegetative conditions, unless directed otherwise by the Field Operations Engineer.

**MOWING**

The minimum mowing height on this project shall be 4 inches.

**MINIMIZE REMOVAL OF VEGETATION**

The Contractor shall minimize removal of vegetation at stream banks and disturbed areas within the project limits as directed.

**NATIVE GRASS SEEDING AND MULCHING**

Native Grass Seeding and Mulching shall be performed on the disturbed areas of wetlands and riparian areas, and adjacent to Stream Relocation construction within a 50 foot zone on both sides of the stream or depression, measured from top of stream bank or center of depression. The stream bank of the stream relocation shall be seeded by a method that does not alter the typical cross section of the stream bank. Native Grass Seeding and Mulching shall also be performed in the permanent soil reinforcement mat section of preformed scour holes, and in other areas as directed.

The kinds of seed and fertilizer, and the rates of application of seed, fertilizer, and limestone, shall be as stated below. During periods of overlapping dates, the kind of seed to be used shall be determined. All rates are in pounds per acre.

**March 1 - August 31**

- 18# Creeping Red Fescue
- 6# Indiangrass
- 8# Little Bluestem
- 4# Switchgrass
- 25# Browntop Millet

**September 1 - February 28**

- 18# Creeping Red Fescue
- 6# Indiangrass
- 8# Little Bluestem
- 4# Switchgrass
- 35# Rye Grain

**DE00085**

500# Fertilizer  
4000# Limestone

500# Fertilizer  
4000# Limestone

Fertilizer shall be 10-20-20 analysis. A different analysis of fertilizer may be used provided the 1-2-2 ratio is maintained and the rate of application adjusted to provide the same amount of plant food as a 10-20-20 analysis and as directed.

Native Grass Seeding and Mulching shall be performed in accordance with Section 1660 of the *Standard Specifications* and vegetative cover sufficient to restrain erosion shall be installed immediately following grade establishment.

**Temporary Seeding**

Fertilizer shall be the same analysis as specified for *Seeding and Mulching* and applied at the rate of 400 pounds and seeded at the rate of 50 pounds per acre. German Millet or Browntop Millet shall be used in summer months and rye grain during the remainder of the year. The Engineer will determine the exact dates for using each kind of seed.

**Fertilizer Topdressing**

Fertilizer used for topdressing shall be 16-8-8 grade and shall be applied at the rate of 500 pounds per acre. A different analysis of fertilizer may be used provided the 2-1-1 ratio is maintained and the rate of application adjusted to provide the same amount of plant food as 16-8-8 analysis and as directed.

**Supplemental Seeding**

The kinds of seed and proportions shall be the same as specified for *Seeding and Mulching*, and the rate of application may vary from 25# to 75# per acre. The actual rate per acre will be determined prior to the time of topdressing and the Contractor will be notified in writing of the rate per acre, total quantity needed, and areas on which to apply the supplemental seed. Minimum tillage equipment, consisting of a sod seeder shall be used for incorporating seed into the soil as to prevent disturbance of existing vegetation. A clodbuster (ball and chain) may be used where degree of slope prevents the use of a sod seeder.

**Mowing**

The minimum mowing height shall be 4 inches.

**Measurement and Payment**

Native Grass *Seeding and Mulching* will be measured and paid for in accordance with Article 1660-8 of the *Standard Specifications*.

**RESPONSE FOR EROSION CONTROL**

**Description**

Furnish the labor, materials, tools and equipment necessary to move personnel, equipment, and supplies to the project necessary for the pursuit of any or all of the following work as shown herein, by an approved subcontractor.

<b>Section</b>	<b>Erosion Control Item</b>	<b>Unit</b>
1605	Temporary Silt Fence	LF
1606	Special Sediment Control Fence	LF/TON
1615	Temporary Mulching	ACR
1620	Seed - Temporary Seeding	LB

DE00085

1620	Fertilizer - Temporary Seeding	TN
1631	Matting for Erosion Control	SY
SP	Coir Fiber Mat	SY
1640	Coir Fiber Baffles	LF
SP	Permanent Soil Reinforcement Mat	SY
1660	Seeding and Mulching	ACR
1661	Seed - Repair Seeding	LB
1661	Fertilizer - Repair Seeding	TON
1662	Seed - Supplemental Seeding	LB
1665	Fertilizer Topdressing	TON
SP	Safety/Highly Visible Fencing	LF
SP	Response for Erosion Control	EA

**Construction Methods**

Provide an approved subcontractor who performs an erosion control action as described in the NPDES Inspection Form SPPP30. Each erosion control action may include one or more of the above work items.

**Measurement and Payment**

*Response for Erosion Control* will be measured and paid for by counting the actual number of times the subcontractor moves onto the project, including borrow and waste sites, and satisfactorily completes an erosion control action described in Form 1675. The provisions of Article 104-5 of the *Standard Specifications* will not apply to this item of work.

Payment will be made under:

<b>Pay Item</b>	<b>Pay Unit</b>
Response for Erosion Control	Each

**SAFETY FENCE AND JURSDICTIONAL FLAGGING**

**Description**

*Safety Fence* shall consist of furnishing materials, installing and maintaining polyethylene or polypropylene fence along the outside riparian buffer, wetland, or water boundary, or other boundaries located within the construction corridor to mark the areas that have been approved to infringe within the buffer, wetland, endangered vegetation, culturally sensitive areas or water. The fence shall be installed prior to any land disturbing activities.

Interior boundaries for jurisdictional areas noted above shall be delineated by stakes and highly visible flagging.

Jurisdictional boundaries at staging areas, waste sites, or borrow pits, whether considered outside or interior boundaries shall be delineated by stakes and highly visible flagging.

**Materials**

- (A) Safety Fencing

**DE00085**

Polyethylene or polypropylene fence shall be a highly visible preconstructed safety fence approved by the Engineer. The fence material shall have an ultraviolet coating.

Either wood posts or steel posts may be used. Wood posts shall be hardwood with a wedge or pencil tip at one end, and shall be at least 5 ft. in length with a minimum nominal 2" x 2" cross section. Steel posts shall be at least 5 ft. in length, and have a minimum weight of 0.85 lb/ft of length.

**(B) Boundary Flagging**

Wooden stakes shall be 4 feet in length with a minimum nominal 3/4"x 1-3/4" cross section. The flagging shall be at least 1" in width. The flagging material shall be vinyl and shall be orange in color and highly visible.

**Construction Methods**

No additional clearing and grubbing is anticipated for the installation of this fence. The fence shall be erected to conform to the general contour of the ground.

**(A) Safety Fencing**

Posts shall be set at a maximum spacing of 10 ft., maintained in a vertical position and hand set or set with a post driver. If hand set, all backfill material shall be thoroughly tamped. Wood posts may be sharpened to a dull point if power driven. Posts damaged by power driving shall be removed and replaced prior to final acceptance. The tops of all wood posts shall be cut at a 30-degree angle. The wood posts may, at the option of the Contractor, be cut at this angle either before or after the posts are erected.

The fence geotextile shall be attached to the wood posts with one 2" galvanized wire staple across each cable or to the steel posts with wire or other acceptable means.

Place construction stakes to establish the location of the safety fence in accordance with Article 105-9 or Article 801-1 of the *Standard Specifications*. No direct pay will be made for the staking of the safety fence. All stakeouts shall be considered incidental to "Construction Surveying", except that where there is no pay item for construction surveying, all safety fence stakeout will be performed by state forces.

The Contractor shall be required to maintain the safety fence in a satisfactory condition for the duration of the project as determined by the Engineer.

**(B) Boundary Flagging**

Boundary flagging delineation of interior boundaries shall consist of wooden stakes on 25 feet maximum intervals with highly visible orange flagging attached. Stakes shall be installed a minimum of 6" into the ground. Interior boundaries may be staked on a tangent that runs parallel to buffer but must not encroach on the buffer at any location. Interior boundaries of hand clearing shall be identified with a different colored flagging to distinguish it from mechanized clearing.

Boundary flagging delineation of interior boundaries will be placed in accordance with Article 105-9 or Article 801-1 of the *Standard Specifications*. No direct pay will be made for delineation of the interior boundaries. All delineation shall be considered incidental to *Construction Surveying*, except that where there is no pay item or construction surveying the cost of boundary flagging delineation shall be included in the unit prices bid for various items in the contract. Installation for delineation of all jurisdictional boundaries at staging areas, waste sites, or borrow pits shall consist of wooden stakes on 25 feet maximum intervals with highly visible orange flagging attached. Stakes shall be installed a minimum of 6" into the ground. Additional flagging may be placed on overhanging vegetation to enhance visibility but does not substitute for installation of stakes.

Installation for delineation of all jurisdictional boundaries at staging areas, waste sites, or borrow pits shall be performed in accordance with Subarticle 230-4(B)(3)(d) or Subarticle 802-2(F) of the *Standard Specifications*. No direct pay will be made for this delineation, as the cost of same shall be included in the unit prices bid for the various items in the contract.



**DE00085**

The Contractor shall be required to maintain alternative stakes and highly visible flagging in a satisfactory condition for the duration of the project as determined by the Engineer.

**Measurement and Payment**

*Safety Fence* will be measured and paid as the actual number of linear feet of polyethylene or polypropylene fence installed in place and accepted. Such payment will be full compensation including but not limited to clearing and grading, furnishing and installing fence geotextile with necessary posts and post bracing, staples, tie wires, tools, equipment and incidentals necessary to complete this work.

Payment will be made under:

<b>Pay Item</b>	<b>Pay Unit</b>
Safety Fence	Linear Foot

**NCDOT GENERAL SEED SPECIFICATION FOR SEED QUALITY**

(5-17-11)

Z-3

Seed shall be sampled and tested by the North Carolina Department of Agriculture and Consumer Services, Seed Testing Laboratory. When said samples are collected, the vendor shall supply an independent laboratory report for each lot to be tested. Results from seed so sampled shall be final. Seed not meeting the specifications shall be rejected by the Department of Transportation and shall not be delivered to North Carolina Department of Transportation warehouses. If seed has been delivered it shall be available for pickup and replacement at the supplier's expense.

Any re-labeling required by the North Carolina Department of Agriculture and Consumer Services, Seed Testing Laboratory, that would cause the label to reflect as otherwise specified herein shall be rejected by the North Carolina Department of Transportation.

Seed shall be free from seeds of the noxious weeds Johnsongrass, Balloonvine, Jimsonweed, Witchweed, Itchgrass, Serrated Tussock, Showy Crotalaria, Smooth Crotalaria, Sicklepod, Sandbur, Wild Onion, and Wild Garlic. Seed shall not be labeled with the above weed species on the seed analysis label. Tolerances as applied by the Association of Official Seed Analysts will NOT be allowed for the above noxious weeds except for Wild Onion and Wild Garlic.

Tolerances established by the Association of Official Seed Analysts will generally be recognized. However, for the purpose of figuring pure live seed, the found pure seed and found germination percentages as reported by the North Carolina Department of Agriculture and Consumer Services, Seed Testing Laboratory will be used. Allowances, as established by the NCDOT, will be recognized for minimum pure live seed as listed on the following pages.

The specifications for restricted noxious weed seed refers to the number per pound as follows:

<u>Restricted Noxious Weed</u>	<u>Limitations per Lb. Of Seed</u>	<u>Restricted Noxious Weed</u>	<u>Limitations per Lb. of Seed</u>
Blessed Thistle	4 seeds	Cornflower (Ragged Robin)	27 seeds
Cocklebur	4 seeds	Texas Panicum	27 seeds
Spurred Anoda	4 seeds	Bracted Plantain	54 seeds
Velvetleaf	4 seeds	Buckhorn Plantain	54 seeds
Morning-glory	8 seeds	Broadleaf Dock	54 seeds
Corn Cockle	10 seeds	Curly Dock	54 seeds
Wild Radish	12 seeds	Dodder	54 seeds
Purple Nutsedge	27 seeds	Giant Foxtail	54 seeds
Yellow Nutsedge	27 seeds	Horsenettle	54 seeds
Canada Thistle	27 seeds	Quackgrass	54 seeds
Field Bindweed	27 seeds	Wild Mustard	54 seeds

DE00085

Hedge Bindweed

27 seeds

Seed of Pensacola Bahiagrass shall not contain more than 7% inert matter, Kentucky Bluegrass, Centipede and Fine or Hard Fescue shall not contain more than 5% inert matter whereas a maximum of 2% inert matter will be allowed on all other kinds of seed. In addition, all seed shall not contain more than 2% other crop seed nor more than 1% total weed seed. The germination rate as tested by the North Carolina Department of Agriculture shall not fall below 70%, which includes both dormant and hard seed. Seed shall be labeled with not more than 7%, 5% or 2% inert matter (according to above specifications), 2% other crop seed and 1% total weed seed.

Exceptions may be made for minimum pure live seed allowances when cases of seed variety shortages are verified. Pure live seed percentages will be applied in a verified shortage situation. Those purchase orders of deficient seed lots will be credited with the percentage that the seed is deficient.

FURTHER SPECIFICATIONS FOR EACH SEED GROUP ARE GIVEN BELOW:

Minimum 85% pure live seed; maximum 1% total weed seed; maximum 2% total other crop seed; maximum 144 restricted noxious weed seed per pound. Seed less than 83% pure live seed will not be approved.

Sericea Lespedeza  
Oats (seeds)

Minimum 80% pure live seed; maximum 1% total weed seed; maximum 2% total other crop; maximum 144 restricted noxious weed seed per pound. Seed less than 78% pure live seed will not be approved.

Tall Fescue (all approved varieties)	Bermudagrass
Kobe Lespedeza	Browntop Millet
Korean Lespedeza	German Millet – Strain R
Weeping Lovegrass	Clover – Red/White/Crimson
Carpetgrass	

Minimum 78% pure live seed; maximum 1% total weed seed; maximum 2% total other crop seed; maximum 144 restricted noxious weed seed per pound. Seed less than 76% pure live seed will not be approved.

Common or Sweet Sundangrass

Minimum 76% pure live seed; maximum 1% total weed seed; maximum 2% total other crop seed; maximum 144 restricted noxious weed seed per pound. Seed less than 74% pure live seed will not be approved.

Rye (grain; all varieties)  
Kentucky Bluegrass (all approved varieties)  
Hard Fescue (all approved varieties)  
Shrub (bicolor) Lespedeza

Minimum 70% pure live seed; maximum 1% total weed seed; maximum 2% total other crop seed; maximum 144 noxious weed seed per pound. Seed less than 70% pure live seed will not be approved.

Centipedegrass	Japanese Millet
Crownvetch	Reed Canary Grass
Pensacola Bahiagrass	Zoysia
Creeping Red Fescue	

Minimum 70% pure live seed; maximum 1% total weed seed; maximum 2% total other crop seed; maximum 5% inert matter; maximum 144 restricted noxious weed seed per pound.

Barnyard Grass  
Big Bluestem  
Little Bluestem  
Bristly Locust

**DE00085**

- Birdsfoot Trefoil
- Indiangrass
- Orchardgrass
- Switchgrass
- Yellow Blossom Sweet Clover

**STABILIZATION REQUIREMENTS**

(11-4-11)

S-1

Stabilization for this project shall comply with the time frame guidelines as specified by the NCG-010000 general construction permit effective August 3, 2011 issued by the North Carolina Department of Environment and Natural Resources Division of Water Quality. Temporary or permanent ground cover stabilization shall occur within 7 calendar days from the last land-disturbing activity, with the following exceptions in which temporary or permanent ground cover shall be provided in 14 calendar days from the last land-disturbing activity:

- Slopes between 2:1 and 3:1, with a slope length of 10 ft. or less
- Slopes 3:1 or flatter, with a slope of length of 50 ft. or less
- Slopes 4:1 or flatter

The stabilization timeframe for High Quality Water (HW) Zones shall be 7 calendar days with no exceptions for slope grades or lengths. High Quality Water Zones (HW) Zones are defined by North Carolina Administrative Code 15A NCAC 04A.0105 (25). Temporary and permanent ground cover stabilization shall be achieved in accordance with the provisions in this contract and as directed.

**SEEDING AND MULCHING**

**East**

The kinds of seed and fertilizer, and the rates of application of seed, fertilizer, and limestone, shall be as stated below. During periods of overlapping dates, the kind of seed to be used shall be determined. All rates are in pounds per acre.

All Roadway Areas

<b>March 1 - August 31</b>		<b>September 1 - February 28</b>	
50#	Tall Fescue	50#	Tall Fescue
10#	Centipede	10#	Centipede
25#	Bermudagrass (hulled)	35#	Bermudagrass (unhulled)
500#	Fertilizer	500#	Fertilizer
4000#	Limestone	4000#	Limestone

Waste and Borrow Locations

<b>March 1 – August 31</b>		<b>September 1 - February 28</b>	
75#	Tall Fescue	75#	Tall Fescue
25#	Bermudagrass (hulled)	35#	Bermudagrass (unhulled)
500#	Fertilizer	500#	Fertilizer
4000#	Limestone	4000#	Limestone

Note: 50# of Bahiagrass may be substituted for either Centipede or Bermudagrass only upon Engineer’s request.

Approved Tall Fescue Cultivars

2 <sup>nd</sup> Millennium	Duster	Magellan	Rendition
Avenger	Endeavor	Masterpiece	Scorpion
Barlexas	Escalade	Matador	Shelby
Barlexas II	Falcon II, III, IV & V	Matador GT	Signia
Barrera	Fidelity	Millennium	Silverstar
Barrington	Finesse II	Montauk	Southern Choice II
Biltmore	Firebird	Mustang 3	Stetson
Bingo	Focus	Olympic Gold	Tarheel

**DE00085**

Bravo	Grande II	Padre	Titan Ltd
Cayenne	Greenkeeper	Paraiso	Titanium
Chapel Hill	Greystone	Picasso	Tomahawk
Chesapeake	Inferno	Piedmont	Tacer
Constitution	Justice	Pure Gold	Trooper
Chipper	Jaguar 3	Prospect	Turbo
Coronado	Kalahari	Quest	Ultimate
Coyote	Kentucky 31	Rebel Exeda	Watchdog
Davinci	Kitty Hawk	Rebel Sentry	Wolfpack
Dynasty	Kitty Hawk 2000	Regiment II	
Dominion	Lexington	Rembrandt	

On cut and fill slopes 2:1 or steeper Centipede shall be applied at the rate of 5 pounds per acre and add 20# of Sericea Lespedeza from January 1 - December 31.

Fertilizer shall be 10-20-20 analysis. A different analysis of fertilizer may be used provided the 1-2-2 ratio is maintained and the rate of application adjusted to provide the same amount of plant food as a 10-20-20 analysis and as directed.

**TEMPORARY SEEDING**

Fertilizer shall be the same analysis as specified for *Seeding and Mulching* and applied at the rate of 400 pounds and seeded at the rate of 50 pounds per acre. Sweet Sudan Grass, German Millet or Browntop Millet shall be used in summer months and Rye Grain during the remainder of the year. The Engineer will determine the exact dates for using each kind of seed.

**SUPPLEMENTAL SEEDING**

The kinds of seed and proportions shall be the same as specified for *Seeding and Mulching*, with the exception that no centipede seed will be used in the seed mix for supplemental seeding. The rate of application for supplemental seeding may vary from 25# to 75# per acre. The actual rate per acre will be determined prior to the time of topdressing and the Contractor will be notified in writing of the rate per acre, total quantity needed, and areas on which to apply the supplemental seed. Minimum tillage equipment, consisting of a sod seeder shall be used for incorporating seed into the soil as to prevent disturbance of existing vegetation. A clodbuster (ball and chain) may be used where degree of slope prevents the use of a sod seeder.

**FERTILIZER TOPDRESSING**

Fertilizer used for topdressing on all roadway areas except slopes 2:1 and steeper shall be 10-20-20 grade and shall be applied at the rate of 500 pounds per acre. A different analysis of fertilizer may be used provided the 1-2-2 ratio is maintained and the rate of application adjusted to provide the same amount of plant food as 10-20-20 analysis and as directed.

Fertilizer used for topdressing on slopes 2:1 and steeper and waste and borrow areas shall be 16-8-8 grade and shall be applied at the rate of 500 pounds per acre. A different analysis of fertilizer may be used provided the 2-1-1 ratio is maintained and the rate of application adjusted to provide the same amount of plant food as 16-8-8 analysis and as directed.

**STOCKPILE AREAS**

The Contractor shall install and maintain erosion control devices sufficient to contain sediment around any erodible material stockpile areas as directed.

**ACCESS AND HAUL ROADS**

At the end of each working day, the Contractor shall install or re-establish temporary diversions or earth berms across access/haul roads to direct runoff into sediment devices. Silt fence sections that are temporarily removed shall be reinstalled across access/haul roads at the end of each working day.

**WASTE AND BORROW SOURCES**

Payment for temporary erosion control measures, except those made necessary by the Contractor's own negligence or for his own convenience, will be paid for at the appropriate contract unit price for the devices or measures utilized in borrow sources and waste areas.

**DE00085**

No additional payment will be made for erosion control devices or permanent seeding and mulching in any commercial borrow or waste pit. All erosion and sediment control practices that may be required on a commercial borrow or waste site will be done at the Contractor's expense.

**COIR FIBER MAT**

**Description**

Furnish material, install and maintain coir fiber mat in locations shown on the plans or in locations as directed. Work includes providing all materials, excavating and backfilling, and placing and securing coir fiber mat with stakes, steel reinforcement bars or staples as directed.

**Materials**

Item	Section
Coir Fiber Mat	1060-14

anchors: Stakes, reinforcement bars, or staples shall be used as anchors.

Wooden Stakes:

Provide hardwood stakes 12"- 24" long with a 2" x 2" nominal square cross section. One end of the stake must be sharpened or beveled to facilitate driving through the coir fiber mat and down into the underlying soil. The other end of the stake needs to have a 1"- 2" long head at the top with a 1"- 2" notch following to catch and secure the coir fiber mat.

Steel Reinforcement Bars:

Provide uncoated #10 steel reinforcement bars 24" nominal length. The bars shall have a 4" diameter bend at one end with a 4" straight section at the tip to catch and secure the coir fiber mat.

Staples:

Provide staples made of 0.125" diameter new steel wire formed into a *u* shape not less than 12" in length with a throat of 1" in width.

**Construction Methods**

Place the coir fiber mat immediately upon final grading. Provide a smooth soil surface free from stones, clods, or debris that will prevent the contact of the mat with the soil. Unroll the mat and apply without stretching such that it will lie smoothly but loosely on the soil surface.

For stream relocation applications, take care to preserve the required line, grade, and cross section of the area covered. Bury the top slope end of each piece of mat in a narrow trench at least 6 in. deep and tamp firmly. Where one roll of matting ends and a second roll begins, overlap the end of the upper roll over the buried end of the second roll so there is a 6 in. overlap. Construct check trenches at least 12 in. deep every 50 ft. longitudinally along the edges of the mat or as directed. Fold over and bury mat to the full depth of the trench, close and tamp firmly. Overlap mat at least 6 in. where 2 or more widths of mat are installed side by side.

Place anchors across the mat at the ends approximately 1 ft. apart. Place anchors along the outer edges and down the center of the mat 3 ft. apart.

Adjustments in the trenching or anchoring requirements to fit individual site conditions may be required.

**Measurement and Payment**

*Coir Fiber Mat* will be measured and paid for as the actual number of square yards measured along the surface of the ground over which coir fiber mat is installed and accepted.

DE00085

No measurement will be made for anchor items.

Payment will be made under:

<b>Pay Item</b>	<b>Pay Unit</b>
Coir Fiber Mat	Square Yard

### **COIR FIBER WATTLE**

#### **Description**

Coir Fiber Wattles are tubular products consisting of coir fibers (coconut fibers) encased in coir fiber netting. Coir Fiber Wattles are used on slopes or channels to intercept runoff and act as a velocity break. Coir Fiber Wattles are to be placed at locations shown on the plans or as directed. Installation shall follow the detail provided in the plans and as directed. Work includes furnishing materials, installation of coir fiber wattles, matting installation, and removing wattles.

#### **Materials**

Coir Fiber Wattle shall meet the following specifications:

100% Coir (Coconut) Fibers	
Minimum Diameter	12 in.
Minimum Density	3.5 lb/ft <sup>3</sup> +/- 10%
Net Material	Coir Fiber
Net Openings	2 in. x 2 in.
Net Strength	90 lbs.
Minimum Weight	2.6 lbs./ft. +/- 10%

Anchors: Stakes shall be used as anchors.

Wooden Stakes:

Provide hardwood stakes a minimum of 2-ft. long with a 2 in. x 2 in. nominal square cross section. One end of the stake must be sharpened or beveled to facilitate driving down into the underlying soil.

Matting shall meet the requirements of Article 1060-8 of the *Standard Specifications*, or shall meet specifications provided elsewhere in this contract.

Provide staples made of 0.125" diameter new steel wire formed into a *u* shape not less than 12" in length with a throat of 1" in width.

#### **Construction Methods**

Coir Fiber Wattles shall be secured to the soil by wire staples approximately every 1 linear foot and at the end of each section of wattle. A minimum of 4 stakes shall be installed on the downstream side of the wattle with a maximum spacing of 2 linear feet along the wattle, and according to the detail. Install a minimum of 2 stakes on the upstream side of the wattle according to the detail provided in the plans. Stakes shall be driven into the ground a minimum of 10 in. with no more than 2 in. projecting from the top of the wattle. Drive stakes at an angle according to the detail provided in the plans.

Only install coir fiber wattle(s) to a height in ditch so flow will not wash around wattle and scour ditch slopes and according to the detail provided in the plans and as directed. Overlap adjoining sections of wattles a minimum of 6 in.

**DE00085**

Installation of matting shall be in accordance with the detail provided in the plans, and in accordance with Article 1631-3 of the *Standard Specifications*, or in accordance with specifications provided elsewhere in this contract.

The Contractor shall maintain the coir fiber wattles until the project is accepted or until the wattles are removed, and shall remove and dispose of silt accumulations at the wattles when so directed in accordance with the requirements of Section 1630 of the *Standard Specifications*.

**Measurement and Payment**

*Coir Fiber Wattles* will be measured and paid for by the actual number of linear feet of wattles which are installed and accepted. Such price and payment will be full compensation for all work covered by this section, including, but not limited to, furnishing all materials, labor, equipment and incidentals necessary to install the *Coir Fiber Wattles*.

Matting will be measured and paid for in accordance with Article 1631-4 of the *Standard Specifications*, or in accordance with specifications provided elsewhere in this contract.

Payment will be made under:

<b>Pay Item</b>	<b>Pay Unit</b>
Coir Fiber Wattle	Linear Foot
<b>SILT FENCE COIR FIBER WATTLE BREAK</b>	
(8-21-12)	1605,1630

**Description**

Silt fence coir fiber wattle breaks are tubular products consisting of coir fibers (coconut fibers) encased in coir fiber netting and used in conjunction with temporary silt fence at the toe of fills to intercept runoff. Silt fence coir fiber wattle breaks are to be placed at locations shown on the plans or as directed. Installation shall follow the detail provided in the plans and as directed. Work includes furnishing materials, installation, maintenance and removing Silt fence coir fiber wattle breaks.

**Materials**

Coir fiber wattle shall meet the following specifications:

100% Coir (Coconut) Fibers	
Minimum Diameter	12"
Minimum Length	10 ft
Minimum Density	3.5 lb/cf ± 10%
Net Material	Coir Fiber
Net Openings	2" x 2"
Net Strength	90 lb.
Minimum Weight	2.6 lb/ft ± 10%

Stakes shall be used as anchors. Provide hardwood stakes a minimum of 2-ft long with a 2" x 2" nominal square cross section. One end of the stake shall be sharpened or beveled to facilitate driving down into the underlying soil.

Provide staples made of 0.125" diameter new steel wire formed into a U-shape not less than 12" in length with a throat of 1" in width.

**Construction Methods**

Excavate a trench the entire length of each wattle with a depth of 1" to 2" for the wattle to be placed. Secure silt fence coir fiber wattle breaks to the soil by wire staples approximately every linear foot and at the end of each wattle. Install at least 4 stakes on the downslope side of the wattle with a maximum spacing of 2 linear feet and

**DE00085**

according to the detail. Install at least 2 stakes on the upslope side of the silt fence coir fiber wattle break according to the detail provided in the plans. Drive stakes into the ground at least 10" with no more than 2" projecting from the top of the wattle. Drive stakes at an angle according to the detail provided in the plans.

Install temporary silt fence in accordance with Section 1605 of the 2012 *Standard Specifications* and overlap each downslope side of silt fence wattle break by 6".

Maintain the silt fence coir fiber wattle breaks until the project is accepted or until the silt fence coir fiber wattle breaks are removed, and remove and dispose of silt accumulations at the silt fence coir fiber wattle breaks when so directed in accordance with Section 1630 of the 2012 *Standard Specifications*.

**Measurement and Payment**

*Coir Fiber Wattle* will be measured and paid as the actual number of linear feet of wattles installed and accepted. Such price and payment will be full compensation for all work covered by this provision, including, but not limited to, furnishing all materials, labor, equipment and incidentals necessary to install the silt fence coir fiber wattle break.

Payment will be made under:

<b>Pay Item</b>	<b>Pay Unit</b>
Coir Fiber Wattle	Linear Foot

**FLOATING TURBIDITY CURTAIN**

**Description**

This work consists of furnishing a *Floating Turbidity Curtain* to deter silt suspension and movement of silt particles during construction. The floating turbidity curtain shall be constructed at locations as directed.

**Materials**

The curtain material shall be made of a tightly woven nylon, plastic or other non-deteriorating material meeting the following specifications:

<b>Property</b>	<b>Value</b>
Grab tensile strength	*md-370 lbs *cd-250 lbs
Mullen burst strength	480 psi
Trapezoid tear strength	*md-100 lbs *cd-60 lbs
Apparent opening size	70 US standard sieve
Percent open area	4% permittivity 0.28 sec-1

\*md - machine direction

\*cd - cross machine direction

In the event that more than one width of fabric is required, a 6" overlap of the material shall also be required.

The curtain material shall be supported by a flotation material having over 29 lbs/ft buoyancy. The floating curtain shall have a 5/16" galvanized chain as ballast and dual 5/16" galvanized wire ropes with a heavy vinyl coating as load lines.

**Construction Methods**

The Contractor shall maintain the *Floating Turbidity Curtain* in a satisfactory condition until its removal is requested by the Engineer. The curtain shall extend to the bottom of the jurisdictional resource. Anchor the curtain according to manufacturer recommendations.

**Measurement and Payment**



**DE00085**

*Floating Turbidity Curtain* will be measured and paid for as the actual number of square yards of curtain furnished as specified and accepted. Such price and payment will be full compensation for the work as described in this section including but not limited to furnishing all materials, tools, equipment, and all incidentals necessary to complete the work.

Payment will be made under:

<b>Pay Item</b>	<b>Pay Unit</b>
Floating Turbidity Curtain	Square Yard

**IMPERVIOUS DIKE**

**Description**

This work consists of furnishing, installing, maintaining, and removing an *Impervious Dike* for the purpose of diverting normal stream flow around the construction site. The Contractor shall construct an impervious dike in such a manner approved by the Engineer. The impervious dike shall not permit seepage of water into the construction site or contribute to siltation of the stream. The impervious dike shall be constructed of an acceptable material in the locations noted on the plans or as directed.

**Materials**

Acceptable materials shall include but not be limited to sheet piles, sandbags, and/or the placement of an acceptable size stone lined with polypropylene or other impervious geotextile.

Earth material shall not be used to construct an impervious dike when it is in direct contact with the stream unless vegetation can be established before contact with the stream takes place.

**Measurement and Payment**

No direct payment will be made for this work, as it will be incidental to the removal of the existing structure.

**ENVIRONMENTALLY SENSITIVE AREAS**

**Description**

This project is located in an *Environmentally Sensitive Area*. This designation requires special procedures to be used for clearing and grubbing, temporary stream crossings, and grading operations within the Environmentally Sensitive Areas identified on the plans and as designated by the Engineer. This also requires special procedures to be used for seeding and mulching and staged seeding within the project.

The Environmentally Sensitive Area shall be defined as a 50-foot buffer zone on both sides of the stream or depression measured from top of streambank or center of depression.

**Construction Methods**

(A) Clearing and Grubbing

In areas identified as Environmentally Sensitive Areas, the Contractor may perform clearing operations, but not grubbing operations until immediately prior to beginning grading operations as described in Article 200-1 of the *Standard Specifications*. Only clearing operations (not grubbing) shall be allowed in this buffer zone until immediately prior to beginning grading operations. Erosion control devices shall be installed immediately following the clearing operation.

(B) Grading

Once grading operations begin in identified Environmentally Sensitive Areas, work shall progress in a continuous manner until complete. All construction within these areas shall progress in a continuous

**DE00085**

manner such that each phase is complete and areas are permanently stabilized prior to beginning of next phase. Failure on the part of the Contractor to complete any phase of construction in a continuous manner in Environmentally Sensitive Areas will be just cause for the Engineer to direct the suspension of work in accordance with Article 108-7 of the *Standard Specifications*.

(C) Temporary Stream Crossings

Any crossing of streams within the limits of this project shall be accomplished in accordance with the requirements of Subarticle 107-13(B) of the *Standard Specifications*.

(D) Seeding and Mulching

Seeding and mulching shall be performed in accordance with Section 1660 of the *Standard Specifications* and vegetative cover sufficient to restrain erosion shall be installed immediately following grade establishment.

Seeding and mulching shall be performed on the areas disturbed by construction immediately following final grade establishment. No appreciable time shall lapse into the contract time without stabilization of slopes, ditches and other areas within the Environmentally Sensitive Areas.

(E) Stage Seeding

The work covered by this section shall consist of the establishment of a vegetative cover on cut and fill slopes as grading progresses. Seeding and mulching shall be done in stages on cut and fill slopes that are greater than 20 feet in height measured along the slope, or greater than 2 acres in area. Each stage shall not exceed the limits stated above.

Additional payments will not be made for the requirements of this section, as the cost for this work shall be included in the contract unit prices for the work involved.

**REFORESTATION**

**Description**

*Reforestation* will be planted within interchanges and along the outside borders of the road, and in other areas as directed. *Reforestation* is not shown on the plan sheets. See the Reforestation Detail Sheet.

All non-maintained riparian buffers impacted by the placement of temporary fill or clearing activities shall be restored to the preconstruction contours and revegetated with native woody species.

The entire *Reforestation* operation shall comply with the requirements of Section 1670 of the *Standard Specifications*.

**Materials**

*Reforestation* shall be bare root seedlings 12"-18" tall.

**Construction Methods**

*Reforestation* shall be planted as soon as practical following permanent *Seeding and Mulching*. The seedlings shall be planted in a 16-foot wide swath adjacent to mowing pattern line, or as directed.

Root dip: The roots of reforestation seedlings shall be coated with a slurry of water, and either a fine clay (kaolin) or a superabsorbent that is designated as a bare root dip. The type, mixture ratio, method of application, and the time of application shall be submitted to the Engineer for approval.

**DE00085**

With the approval of the Engineer, seedlings may be coated before delivery to the job or at the time of planting, but at no time shall the roots of the seedlings be allowed to dry out. The roots shall be moistened immediately prior to planting.

Seasonal Limitations: *Reforestation* shall be planted from November 15 through March 15.

**Measurement and Payment**

*Reforestation* will be measured and paid for in accordance with Article 1670-17 of the *Standard Specifications*.



## PERMITS

The Contractor's attention is directed to the following permits, which have been issued to the Department of Transportation by the authority granting the permit. The permit package is considered part and parcel of this proposal.

<u>PERMIT</u>	<u>AUTHORITY GRANTING THE PERMIT</u>
Dredge and Fill and/or Work in Navigable Waters (404)	U. S. Army Corps of Engineers
Water Quality (401)	Division of Water Quality, DENR State of North Carolina
Buffer Certification	Division of Water Quality, DENR State of North Carolina

The Contractor shall comply with all applicable permit conditions during construction of this project. Those conditions marked by \* are the responsibility of the department and the Contractor has no responsibility in accomplishing those conditions.

Agents of the permitting authority will periodically inspect the project for adherence to the permits.

The Contractor's attention is also directed to Articles 107-10 and 107-13 of the *2012 Standard Specifications* and the following:

Should the Contractor propose to utilize construction methods (such as temporary structures or fill in waters and/or wetlands for haul roads, work platforms, cofferdams, etc.) not specifically identified in the permit (individual, general, or nationwide) authorizing the project it shall be the Contractor's responsibility to coordinate with the Engineer to determine what, if any, additional permit action is required. The Contractor shall also be responsible for initiating the request for the authorization of such construction method by the permitting agency. The request shall be submitted through the Engineer. The Contractor shall not utilize the construction method until it is approved by the permitting agency. The request normally takes approximately 60 days to process; however, no extensions of time or additional compensation will be granted for delays resulting from the Contractor's request for approval of construction methods not specifically identified in the permit.

**Where construction moratoriums are contained in a permit condition which restricts the Contractor's activities to certain times of the year, those moratoriums will apply only to the portions of the work taking place in the waters or wetlands provided that activities outside those areas is done in such a manner as to not affect the waters or wetlands.**



Project Special Provisions  
Structure

Table of Contents

	Page #
Falsework and Formwork (4-5-12)	..... 1
Submittal of Working Drawings (8-9-13)	..... 7
Crane Safety (8-15-05)	..... 13
Grout for Structures (9-30-11)	..... 13
Pile Driving Criteria (9-18-12)	..... 15



559 Jones Franklin Rd.  
Suite 164  
Raleigh, NC 27606  
License No. F-0377

**FALSEWORK AND FORMWORK**

(4-5-12)

**1.0 DESCRIPTION**

Use this Special Provision as a guide to develop temporary works submittals required by the Standard Specifications or other provisions; no additional submittals are required herein. Such temporary works include, but are not limited to, falsework and formwork.

Falsework is any temporary construction used to support the permanent structure until it becomes self-supporting. Formwork is the temporary structure or mold used to retain plastic or fluid concrete in its designated shape until it hardens. Access scaffolding is a temporary structure that functions as a work platform that supports construction personnel, materials, and tools, but is not intended to support the structure. Scaffolding systems that are used to temporarily support permanent structures (as opposed to functioning as work platforms) are considered to be falsework under the definitions given. Shoring is a component of falsework such as horizontal, vertical, or inclined support members. Where the term “temporary works” is used, it includes all of the temporary facilities used in bridge construction that do not become part of the permanent structure.

Design and construct safe and adequate temporary works that will support all loads imposed and provide the necessary rigidity to achieve the lines and grades shown on the plans in the final structure.

**2.0 MATERIALS**

Select materials suitable for temporary works; however, select materials that also ensure the safety and quality required by the design assumptions. The Engineer has authority to reject material on the basis of its condition, inappropriate use, safety, or nonconformance with the plans. Clearly identify allowable loads or stresses for all materials or manufactured devices on the plans. Revise the plan and notify the Engineer if any change to materials or material strengths is required.

**3.0 DESIGN REQUIREMENTS****A. Working Drawings**

Provide working drawings for items as specified in the contract, or as required by the Engineer, with design calculations and supporting data in sufficient detail to permit a structural and safety review of the proposed design of the temporary work.

On the drawings, show all information necessary to allow the design of any component to be checked independently as determined by the Engineer.

When concrete placement is involved, include data such as the drawings of proposed sequence, rate of placement, direction of placement, and location of all construction joints. Submit the number of copies as called for by the contract.

When required, have the drawings and calculations prepared under the guidance of, and sealed by, a North Carolina Registered Professional Engineer who is knowledgeable in temporary works design.



If requested by the Engineer, submit with the working drawings manufacturer's catalog data listing the weight of all construction equipment that will be supported on the temporary work. Show anticipated total settlements and/or deflections of falsework and forms on the working drawings. Include falsework footing settlements, joint take-up, and deflection of beams or girders.

As an option for the Contractor, overhang falsework hangers may be uniformly spaced, at a maximum of 36 inches, provided the following conditions are met:

Member Type (PCG)	Member Depth, (inches)	Max. Overhang Width, (inches)	Max. Slab Edge Thickness, (inches)	Max. Screenshot Wheel Weight, (lbs.)	Bracket Min. Vertical Leg Extension, (inches)
II	36	39	14	2000	26
III	45	42	14	2000	35
IV	54	45	14	2000	44
MBT	63	51	12	2000	50
MBT	72	55	12	1700	48

Overhang width is measured from the centerline of the girder to the edge of the deck slab.

For Type II, III & IV prestressed concrete girders (PCG), 45-degree cast-in-place half hangers and rods must have a minimum safe working load of 6,000 lbs.

For MBT prestressed concrete girders, 45-degree angle holes for falsework hanger rods shall be cast through the girder top flange and located, measuring along the top of the member, 1'-2 1/2" from the edge of the top flange. Hanger hardware and rods must have a minimum safe working load of 6,000 lbs.

The overhang bracket provided for the diagonal leg shall have a minimum safe working load of 3,750 lbs. The vertical leg of the bracket shall extend to the point that the heel bears on the girder bottom flange, no closer than 4 inches from the bottom of the member. However, for 72-inch members, the heel of the bracket shall bear on the web, near the bottom flange transition.

Provide adequate overhang falsework and determine the appropriate adjustments for deck geometry, equipment, casting procedures and casting conditions.

If the optional overhang falsework spacing is used, indicate this on the falsework submittal and advise the girder producer of the proposed details. Failure to notify the Engineer of hanger type and hanger spacing on prestressed concrete girder casting drawings may delay the approval of those drawings.

Falsework hangers that support concentrated loads and are installed at the edge of thin top flange concrete girders (such as bulb tee girders) shall be spaced so as not to exceed 75% of the manufacturer's stated safe working load. Use of dual leg hangers (such as Meadow Burke HF-42 and HF-43) are not allowed on concrete girders with thin top flanges. Design the falsework and forms supporting deck slabs and overhangs on girder

bridges so that there will be no differential settlement between the girders and the deck forms during placement of deck concrete.

When staged construction of the bridge deck is required, detail falsework and forms for screed and fluid concrete loads to be independent of any previous deck pour components when the mid-span girder deflection due to deck weight is greater than  $\frac{3}{4}$ ".

Note on the working drawings any anchorages, connectors, inserts, steel sleeves or other such devices used as part of the falsework or formwork that remains in the permanent structure. If the plan notes indicate that the structure contains the necessary corrosion protection required for a Corrosive Site, epoxy coat, galvanize or metalize these devices. Electroplating will not be allowed. Any coating required by the Engineer will be considered incidental to the various pay items requiring temporary works.

Design falsework and formwork requiring submittals in accordance with the 1995 AASHTO *Guide Design Specifications for Bridge Temporary Works* except as noted herein.

#### 1. Wind Loads

Table 2.2 of Article 2.2.5.1 is modified to include wind velocities up to 110 mph. In addition, Table 2.2A is included to provide the maximum wind speeds by county in North Carolina.

**Table 2.2 - Wind Pressure Values**

Height Zone feet above ground	Pressure, lb/ft <sup>2</sup> for Indicated Wind Velocity, mph				
	70	80	90	100	110
0 to 30	15	20	25	30	35
30 to 50	20	25	30	35	40
50 to 100	25	30	35	40	45
over 100	30	35	40	45	50

#### 2. Time of Removal

The following requirements replace those of Article 3.4.8.2.

Do not remove forms until the concrete has attained strengths required in Article 420-16 of the Standard Specifications and these Special Provisions.

Do not remove forms until the concrete has sufficient strength to prevent damage to the surface.

**Table 2.2A - Steady State Maximum Wind Speeds by Counties in North Carolina**

COUNTY	25 YR (mph)	COUNTY	25 YR (mph)	COUNTY	25 YR (mph)
Alamance	70	Franklin	70	Pamlico	100
Alexander	70	Gaston	70	Pasquotank	100
Alleghany	70	Gates	90	Pender	100
Anson	70	Graham	80	Perquimans	100
Ashe	70	Granville	70	Person	70
Avery	70	Greene	80	Pitt	90
Beaufort	100	Guilford	70	Polk	80
Bertie	90	Halifax	80	Randolph	70
Bladen	90	Harnett	70	Richmond	70
Brunswick	100	Haywood	80	Robeson	80
Buncombe	80	Henderson	80	Rockingham	70
Burke	70	Hertford	90	Rowan	70
Cabarrus	70	Hoke	70	Rutherford	70
Caldwell	70	Hyde	110	Sampson	90
Camden	100	Iredell	70	Scotland	70
Carteret	110	Jackson	80	Stanley	70
Caswell	70	Johnston	80	Stokes	70
Catawba	70	Jones	100	Surry	70
Cherokee	80	Lee	70	Swain	80
Chatham	70	Lenoir	90	Transylvania	80
Chowan	90	Lincoln	70	Tyrell	100
Clay	80	Macon	80	Union	70
Cleveland	70	Madison	80	Vance	70
Columbus	90	Martin	90	Wake	70
Craven	100	McDowell	70	Warren	70
Cumberland	80	Mecklenburg	70	Washington	100
Currituck	100	Mitchell	70	Watauga	70
Dare	110	Montgomery	70	Wayne	80
Davidson	70	Moore	70	Wilkes	70
Davie	70	Nash	80	Wilson	80
Duplin	90	New Hanover	100	Yadkin	70
Durham	70	Northampton	80	Yancey	70
Edgecombe	80	Onslow	100		
Forsyth	70	Orange	70		

## B. Review and Approval

The Engineer is responsible for the review and approval of temporary works' drawings.

Submit the working drawings sufficiently in advance of proposed use to allow for their review, revision (if needed), and approval without delay to the work.

The time period for review of the working drawings does not begin until complete drawings and design calculations, when required, are received by the Engineer.

Do not start construction of any temporary work for which working drawings are required until the drawings have been approved. Such approval does not relieve the Contractor of the responsibility for the accuracy and adequacy of the working drawings.

## 4.0 CONSTRUCTION REQUIREMENTS

All requirements of Section 420 of the Standard Specifications apply.

Construct temporary works in conformance with the approved working drawings. Ensure that the quality of materials and workmanship employed is consistent with that assumed in the design of the temporary works. Do not weld falsework members to any portion of the permanent structure unless approved. Show any welding to the permanent structure on the approved construction drawings.

Provide tell-tales attached to the forms and extending to the ground, or other means, for accurate measurement of falsework settlement. Make sure that the anticipated compressive settlement and/or deflection of falsework does not exceed 1 inch. For cast-in-place concrete structures, make sure that the calculated deflection of falsework flexural members does not exceed 1/240 of their span regardless of whether or not the deflection is compensated by camber strips.

### A. Maintenance and Inspection

Inspect and maintain the temporary work in an acceptable condition throughout the period of its use. Certify that the manufactured devices have been maintained in a condition to allow them to safely carry their rated loads. Clearly mark each piece so that its capacity can be readily determined at the job site.

Perform an in-depth inspection of an applicable portion(s) of the temporary works, in the presence of the Engineer, not more than 24 hours prior to the beginning of each concrete placement. Inspect other temporary works at least once a month to ensure that they are functioning properly. Have a North Carolina Registered Professional Engineer inspect the cofferdams, shoring, sheathing, support of excavation structures, and support systems for load tests prior to loading.

**B. Foundations**

Determine the safe bearing capacity of the foundation material on which the supports for temporary works rest. If required by the Engineer, conduct load tests to verify proposed bearing capacity values that are marginal or in other high-risk situations.

The use of the foundation support values shown on the contract plans of the permanent structure is permitted if the foundations are on the same level and on the same soil as those of the permanent structure.

Allow for adequate site drainage or soil protection to prevent soil saturation and washout of the soil supporting the temporary works supports.

If piles are used, the estimation of capacities and later confirmation during construction using standard procedures based on the driving characteristics of the pile is permitted. If preferred, use load tests to confirm the estimated capacities; or, if required by the Engineer conduct load tests to verify bearing capacity values that are marginal or in other high risk situations.

The Engineer reviews and approves the proposed pile and soil bearing capacities.

**5.0 REMOVAL**

Unless otherwise permitted, remove and keep all temporary works upon completion of the work. Do not disturb or otherwise damage the finished work.

Remove temporary works in conformance with the contract documents. Remove them in such a manner as to permit the structure to uniformly and gradually take the stresses due to its own weight.

**6.0 METHOD OF MEASUREMENT**

Unless otherwise specified, temporary works will not be directly measured.

**7.0 BASIS OF PAYMENT**

Payment at the contract unit prices for the various pay items requiring temporary works will be full compensation for the above falsework and formwork.

**SUBMITTAL OF WORKING DRAWINGS****(8-9-13)****1.0 GENERAL**

Submit working drawings in accordance with Article 105-2 of the *Standard Specifications* and this provision. For this provision, “submittals” refers to only those listed in this provision. The list of submittals contained herein does not represent a list of required submittals for the project. Submittals are only necessary for those items as required by the contract. Make submittals that are not specifically noted in this provision directly to the Resident Engineer. Either the Structure Design Unit or the Geotechnical Engineering Unit or both units will jointly review submittals.

If a submittal contains variations from plan details or specifications or significantly affects project cost, field construction or operations, discuss the submittal with and submit all copies to the Resident Engineer. State the reason for the proposed variation in the submittal. To minimize review time, make sure all submittals are complete when initially submitted. Provide a contact name and information with each submittal. Direct any questions regarding submittal requirements to the Resident Engineer, Structure Design Unit contacts or the Geotechnical Engineering Unit contacts noted below.

In order to facilitate in-plant inspection by NCDOT and approval of working drawings, provide the name, address and telephone number of the facility where fabrication will actually be done if different than shown on the title block of the submitted working drawings. This includes, but is not limited to, precast concrete items, prestressed concrete items and fabricated steel or aluminum items.

**2.0 ADDRESSES AND CONTACTS**

For submittals to the Structure Design Unit, use the following addresses:

Via US mail:

Mr. G. R. Perfetti, P. E.  
State Structures Engineer  
North Carolina Department  
of Transportation  
Structures Management Unit  
1581 Mail Service Center  
Raleigh, NC 27699-1581

Attention: Mr. P. D. Lambert, P. E.

Via other delivery service:

Mr. G. R. Perfetti, P. E.  
State Structures Engineer  
North Carolina Department  
of Transportation  
Structures Management Unit  
1000 Birch Ridge Drive  
Raleigh, NC 27610

Attention: Mr. P. D. Lambert, P. E.

Submittals may also be made via email.

Send submittals to:

[plambert@ncdot.gov](mailto:plambert@ncdot.gov) (Paul Lambert)

Send an additional e-copy of the submittal to the following address:

[jgaither@ncdot.gov](mailto:jgaither@ncdot.gov) (James Gaither)

[jlbolden@ncdot.gov](mailto:jlbolden@ncdot.gov) (James Bolden)

For submittals to the Geotechnical Engineering Unit, use the following addresses:

For projects in Divisions 1-7, use the following Eastern Regional Office address:

Via US mail:

Mr. K. J. Kim, Ph. D., P. E.  
Eastern Regional Geotechnical  
Manager  
North Carolina Department  
of Transportation  
Geotechnical Engineering Unit  
Eastern Regional Office  
1570 Mail Service Center  
Raleigh, NC 27699-1570

Via other delivery service:

Mr. K. J. Kim, Ph. D., P. E.  
Eastern Regional Geotechnical  
Manager  
North Carolina Department  
of Transportation  
Geotechnical Engineering Unit  
Eastern Regional Office  
3301 Jones Sausage Road, Suite 100  
Garner, NC 27529

For projects in Divisions 8-14, use the following Western Regional Office address:

Via US mail:

Mr. Eric Williams, P. E.  
Western Regional Geotechnical  
Manager  
North Carolina Department  
of Transportation  
Geotechnical Engineering Unit  
Western Regional Office  
5253 Z Max Boulevard  
Harrisburg, NC 28075

Via other delivery service:

Mr. Eric Williams, P. E.  
Western Region Geotechnical  
Manager  
North Carolina Department  
of Transportation  
Geotechnical Engineering Unit  
Western Regional Office  
5253 Z Max Boulevard  
Harrisburg, NC 28075

The status of the review of structure-related submittals sent to the Structure Design Unit can be viewed from the Unit's web site, via the "Contractor Submittal" link.

Direct any questions concerning submittal review status, review comments or drawing markups to the following contacts:

Primary Structures Contact: Paul Lambert (919) 707 – 6407  
(919) 250 – 4082 facsimile  
[plambert@ncdot.gov](mailto:plambert@ncdot.gov)

Secondary Structures Contacts: James Gaither (919) 707 – 6409  
James Bolden (919) 707 – 6408

Eastern Regional Geotechnical Contact (Divisions 1-7):

K. J. Kim  
(919) 662 – 4710  
(919) 662 – 3095 facsimile  
[kkim@ncdot.gov](mailto:kkim@ncdot.gov)

Western Regional Geotechnical Contact (Divisions 8-14):

Eric Williams (704) 455 – 8902  
(704) 455 – 8912 facsimile  
[ewilliams@ncdot.gov](mailto:ewilliams@ncdot.gov)

### 3.0 SUBMITTAL COPIES

Furnish one complete copy of each submittal, including all attachments, to the Resident Engineer. At the same time, submit the number of hard copies shown below of the same complete submittal directly to the Structure Design Unit and/or the Geotechnical Engineering Unit.

The first table below covers “Structure Submittals”. The Resident Engineer will receive review comments and drawing markups for these submittals from the Structure Design Unit. The second table in this section covers “Geotechnical Submittals”. The Resident Engineer will receive review comments and drawing markups for these submittals from the Geotechnical Engineering Unit.

Unless otherwise required, submit one set of supporting calculations to either the Structure Design Unit or the Geotechnical Engineering Unit unless both units require submittal copies in which case submit a set of supporting calculations to each unit. Provide additional copies of any submittal as directed.

#### STRUCTURE SUBMITTALS

Submittal	Copies Required by Structure Design Unit	Copies Required by Geotechnical Engineering Unit	Contract Reference Requiring Submittal <sup>1</sup>
Arch Culvert Falsework	5	0	Plan Note, SN Sheet & “Falsework and Formwork”
Box Culvert Falsework <sup>7</sup>	5	0	Plan Note, SN Sheet & “Falsework and Formwork”
Cofferdams	6	2	Article 410-4
Foam Joint Seals <sup>6</sup>	9	0	“Foam Joint Seals”
Expansion Joint Seals (hold down plate type with base angle)	9	0	“Expansion Joint Seals”
Expansion Joint Seals (modular)	2, then 9	0	“Modular Expansion Joint Seals”
Expansion Joint Seals (strip seals)	9	0	“Strip Seals”
Falsework & Forms <sup>2</sup> (substructure)	8	0	Article 420-3 & “Falsework and Formwork”
Falsework & Forms (superstructure)	8	0	Article 420-3 & “Falsework and Formwork”
Girder Erection over Railroad	5	0	Railroad Provisions



Maintenance and Protection of Traffic Beneath Proposed Structure	8	0	“Maintenance and Protection of Traffic Beneath Proposed Structure at Station ____”
Metal Bridge Railing	8	0	Plan Note
Metal Stay-in-Place Forms	8	0	Article 420-3
Metalwork for Elastomeric Bearings <sup>4,5</sup>	7	0	Article 1072-8
Miscellaneous Metalwork <sup>4,5</sup>	7	0	Article 1072-8
Optional Disc Bearings <sup>4</sup>	8	0	“Optional Disc Bearings”
Overhead and Digital Message Signs (DMS) (metalwork and foundations)	13	0	Applicable Provisions
Placement of Equipment on Structures (cranes, etc.)	7	0	Article 420-20
Pot Bearings <sup>4</sup>	8	0	“Pot Bearings”
Precast Concrete Box Culverts	2, then 1 reproducible	0	“Optional Precast Reinforced Concrete Box Culvert at Station ____”
Prestressed Concrete Cored Slab (detensioning sequences) <sup>3</sup>	6	0	Article 1078-11
Prestressed Concrete Deck Panels	6 and 1 reproducible	0	Article 420-3
Prestressed Concrete Girder (strand elongation and detensioning sequences)	6	0	Articles 1078-8 and 1078-11
Removal of Existing Structure over Railroad	5	0	Railroad Provisions
Revised Bridge Deck Plans (adaptation to prestressed deck panels)	2, then 1 reproducible	0	Article 420-3
Revised Bridge Deck Plans (adaptation to modular expansion joint seals)	2, then 1 reproducible	0	“Modular Expansion Joint Seals”
Sound Barrier Wall (precast items)	10	0	Article 1077-2 & “Sound Barrier Wall”
Sound Barrier Wall Steel Fabrication Plans <sup>5</sup>	7	0	Article 1072-8 & “Sound Barrier Wall”

Structural Steel <sup>4</sup>	2, then 7	0	Article 1072-8
Temporary Detour Structures	10	2	Article 400-3 & “Construction, Maintenance and Removal of Temporary Structure at Station _____”
TFE Expansion Bearings <sup>4</sup>	8	0	Article 1072-8

#### FOOTNOTES

1. References are provided to help locate the part of the contract where the submittals are required. References in quotes refer to the provision by that name. Articles refer to the *Standard Specifications*.
2. Submittals for these items are necessary only when required by a note on plans.
3. Submittals for these items may not be required. A list of pre-approved sequences is available from the producer or the Materials & Tests Unit.
4. The fabricator may submit these items directly to the Structure Design Unit.
5. The two sets of preliminary submittals required by Article 1072-8 of the *Standard Specifications* are not required for these items.
6. Submittals for Fabrication Drawings are not required. Submittals for Catalogue Cuts of Proposed Material are required. See Section 5.A of the referenced provision.
7. Submittals are necessary only when the top slab thickness is 18" or greater.

**GEOTECHNICAL SUBMITTALS**

<b>Submittal</b>	<b>Copies Required by Geotechnical Engineering Unit</b>	<b>Copies Required by Structure Design Unit</b>	<b>Contract Reference Requiring Submittal<sup>1</sup></b>
Drilled Pier Construction Plans <sup>2</sup>	1	0	Subarticle 411-3(A)
Crosshole Sonic Logging (CSL) Reports <sup>2</sup>	1	0	Subarticle 411-5(A)(2)
Pile Driving Equipment Data Forms <sup>2,3</sup>	1	0	Subarticle 450-3(D)(2)
Pile Driving Analyzer (PDA) Reports <sup>2</sup>	1	0	Subarticle 450-3(F)(3)
Retaining Walls <sup>4</sup>	8 drawings, 2 calculations	2 drawings	Applicable Provisions
Temporary Shoring <sup>4</sup>	5 drawings, 2 calculations	2 drawings	“Temporary Shoring” & “Temporary Soil Nail Walls”

**FOOTNOTES**

- References are provided to help locate the part of the contract where the submittals are required. References in quotes refer to the provision by that name. Subarticles refer to the *Standard Specifications*.
- Submit one hard copy of submittal to the Resident or Bridge Maintenance Engineer. Submit a second copy of submittal electronically (PDF via email) or by facsimile, US mail or other delivery service to the appropriate Geotechnical Engineering Unit regional office. Electronic submission is preferred.
- The Pile Driving Equipment Data Form is available from:  
[www.ncdot.org/doh/preconstruct/highway/geotech/formdet/](http://www.ncdot.org/doh/preconstruct/highway/geotech/formdet/)  
See second page of form for submittal instructions.
- Electronic copy of submittal is required. See referenced provision.

**CRANE SAFETY****(8-15-05)**

Comply with the manufacturer specifications and limitations applicable to the operation of any and all cranes and derricks. Prime contractors, sub-contractors, and fully operated rental companies shall comply with the current Occupational Safety and Health Administration regulations (OSHA).

Submit all items listed below to the Engineer prior to beginning crane operations involving critical lifts. A critical lift is defined as any lift that exceeds 75 percent of the manufacturer's crane chart capacity for the radius at which the load will be lifted or requires the use of more than one crane. Changes in personnel or equipment must be reported to the Engineer and all applicable items listed below must be updated and submitted prior to continuing with crane operations.

**Crane Safety Submittal List**

- A. **Competent Person:** Provide the name and qualifications of the "Competent Person" responsible for crane safety and lifting operations. The named competent person will have the responsibility and authority to stop any work activity due to safety concerns.  
**Riggers:** Provide the qualifications and experience of the persons responsible for rigging operations. Qualifications and experience should include, but not be limited to, weight calculations, center of gravity determinations, selection and inspection of sling and rigging equipment, and safe rigging practices.
- B. **Crane Inspections:** Inspection records for all cranes shall be current and readily accessible for review upon request.
- C. **Certifications:** **By July 1, 2006**, crane operators performing critical lifts shall be certified by NC CCO (National Commission for the Certification of Crane Operators), or satisfactorily complete the Carolinas AGC's Professional Crane Operator's Proficiency Program. Other approved nationally accredited programs will be considered upon request. All crane operators shall also have a current CDL medical card. Submit a list of anticipated critical lifts and corresponding crane operator(s). Include current certification for the type of crane operated (small hydraulic, large hydraulic, small lattice, large lattice) and medical evaluations for each operator.

**GROUT FOR STRUCTURES****(9-30-11)****1.0 DESCRIPTION**

This special provision addresses grout for use in pile blockouts, grout pockets, shear keys, dowel holes and recesses for structures. This provision does not apply to grout placed in post-tensioning ducts for bridge beams, girders, or decks. Mix and place grout in accordance with the manufacturer's recommendations, the applicable sections of the Standard Specifications and this provision.

## 2.0 MATERIAL REQUIREMENTS

Use a Department approved pre-packaged, non-shrink, non-metallic grout. Contact the Materials and Tests Unit for a list of approved pre-packaged grouts and consult the manufacturer to determine if the pre-packaged grout selected is suitable for the required application.

When using an approved pre-packaged grout, a grout mix design submittal is not required.

The grout shall be free of soluble chlorides and contain less than one percent soluble sulfate. Supply water in compliance with Article 1024-4 of the Standard Specifications.

Aggregate may be added to the mix only where recommended or permitted by the manufacturer and Engineer. The quantity and gradation of the aggregate shall be in accordance with the manufacturer's recommendations.

Admixtures, if approved by the Department, shall be used in accordance with the manufacturer's recommendations. The manufacture date shall be clearly stamped on each container. Admixtures with an expired shelf life shall not be used.

The Engineer reserves the right to reject material based on unsatisfactory performance.

Initial setting time shall not be less than 10 minutes when tested in accordance with ASTM C266.

Test the expansion and shrinkage of the grout in accordance with ASTM C1090. The grout shall expand no more than 0.2% and shall exhibit no shrinkage. Furnish a Type 4 material certification showing results of tests conducted to determine the properties listed in the Standard Specifications and to assure the material is non-shrink.

Unless required elsewhere in the contract the compressive strength at 3 days shall be at least 5000 psi. Compressive strength in the laboratory shall be determined in accordance with ASTM C109 except the test mix shall contain only water and the dry manufactured material. Compressive strength in the field will be determined by molding and testing 4" x 8" cylinders in accordance with AASHTO T22. Construction loading and traffic loading shall not be allowed until the 3 day compressive strength is achieved.

When tested in accordance with ASTM C666, Procedure A, the durability factor of the grout shall not be less than 80.

## 3.0 SAMPLING AND PLACEMENT

Place and maintain components in final position until grout placement is complete and accepted. Concrete surfaces to receive grout shall be free of defective concrete, laitance, oil, grease and other foreign matter. Saturate concrete surfaces with clean water and remove excess water prior to placing grout.

Do not place grout if the grout temperature is less than 50°F or more than 90°F or if the air temperature measured at the location of the grouting operation in the shade away from artificial heat is below 45°F.

Provide grout at a rate that permits proper handling, placing and finishing in accordance with the manufacturer's recommendations unless directed otherwise by the Engineer. Use grout free of any lumps and undispersed cement. Agitate grout continuously before placement.

Control grout delivery so the interval between placing batches in the same component does not exceed 20 minutes.

The Engineer will determine the locations to sample grout and the number and type of samples collected for field and laboratory testing. The compressive strength of the grout will be considered the average compressive strength test results of 3 cube or 2 cylinder specimens at 28 days.

#### 4.0 BASIS OF PAYMENT

No separate payment will be made for "Grout for Structures". The cost of the material, equipment, labor, placement, and any incidentals necessary to complete the work shall be considered incidental to the structure item requiring grout.

#### **PILE DRIVING CRITERIA**

**(9-18-12)**

Revise the *2012 Standard Specifications* as follows:

**Page 4-72, Subarticle 450-3(D)(3) Required Driving Resistance, lines 26-30**, delete first paragraph and replace with the following:

The Engineer will determine if the proposed pile driving methods and equipment are acceptable and provide the blows/ft and equivalent set for the required driving resistance noted in the plans, i.e., "pile driving criteria" except for structures with pile driving analyzer (PDA) testing. For structures with PDA testing, provide pile driving criteria for any bents and end bents with piles in accordance with Subarticle 450-3(F)(4).

**Page 4-73, Subarticle 450-3(F) Pile Driving Analyzer, lines 45-48**, delete third paragraph and replace with the following:

The Engineer will complete the review of the proposed pile driving methods and equipment within 7 days of receiving PDA reports and pile driving criteria. Do not place concrete for caps or footings on piles until PDA reports and pile driving criteria have been accepted.

**Page 4-75, Subarticle 450-3(F) Pile Driving Analyzer**, add the following:

(4) Pile Driving Criteria

Analyze pile driving with the GRL Wave Equation Analysis Program (GRLWEAP) manufactured by Pile Dynamics, Inc. Use the same PDA Consultant that provides PDA reports to perform GRLWEAP analyses and develop pile driving criteria. Provide driving criteria sealed by an engineer approved as a Project Engineer (key person) for the same PDA Consultant.

Analyze pile driving so driving stresses, energy transfer, ram stroke and blows/ft from PDA testing and resistances from CAPWAP analyses correlate to GRLWEAP models. Provide pile driving criteria for each combination of required driving resistance and pile

length installed for all pile types and sizes. Submit 2 copies of pile driving criteria with PDA reports. Include the following for driving criteria:

- (a) Project information in accordance with Subarticle 450-3(F)(3)(a)
- (b) Table showing blows/ft and equivalent set vs. either stroke for multiple strokes in increments of 6" or bounce chamber pressure for multiple pressures in increments of 1 psi
- (c) Maximum stroke or blows/ft or pile cushion requirements to prevent overstressing piles as needed
- (d) GRLWEAP software version information
- (e) PDF copy of all pile driving criteria and executable GRLWEAP input and output files

**Page 4-76, Article 450-4 MEASUREMENT AND PAYMENT**, add the following:

The contract unit price for *PDA Testing* will also be full compensation for performing GRLWEAP analysis and developing and providing pile driving criteria.





# STANDARD SPECIAL PROVISION

## ERRATA

(1-17-12) (Rev. 1-21-14)

Z-4

Revise the *2012 Standard Specifications* as follows:

### Division 2

**Page 2-7, line 31, Article 215-2 Construction Methods**, replace “Article 107-26” with “Article 107-25”.

**Page 2-17, Article 226-3, Measurement and Payment, line 2**, delete “pipe culverts,”.

**Page 2-20, Subarticle 230-4(B), Contractor Furnished Sources, change references as follows: Line 1**, replace “(4) Buffer Zone” with “(c) Buffer Zone”; **Line 12**, replace “(5) Evaluation for Potential Wetlands and Endangered Species” with “(d) Evaluation for Potential Wetlands and Endangered Species”; and **Line 33**, replace “(6) Approval” with “(4) Approval”.

### Division 3

**Page 3-1, after line 15, Article 300-2 Materials**, replace “1032-9(F)” with “1032-6(F)”.

### Division 4

**Page 4-77, line 27, Subarticle 452-3(C) Concrete Coping**, replace “sheet pile” with “reinforcement”.

### Division 6

**Page 6-7, line 31, Article 609-3 Field Verification of Mixture and Job Mix Formula Adjustments**, replace “30” with “45”.

**Page 6-10, line 42, Subarticle 609-6(C)(2)**, replace “Subarticle 609-6(E)” with “Subarticle 609-6(D)”.

**Page 6-11, Table 609-1 Control Limits**, replace “Max. Spec. Limit” for the Target Source of  $P_{0.075}/P_{be}$  Ratio with “1.0”.

**Page 6-40, Article 650-2 Materials**, replace “Subarticle 1012-1(F)” with “Subarticle 1012-1(E)”.

### Division 8

**Page 8-23, line 10, Article 838-2 Materials**, replace “Portland Cement Concrete, Class B” with “Portland Cement Concrete, Class A”.

### Division 12

**Page 12-7, Table 1205-3**, add “FOR THERMOPLASTIC” to the end of the title.

**Page 12-8, Subarticle 1205-5(B), line 13**, replace “Table 1205-2” with “Table 1205-4”.

**Page 12-8, Table 1205-4 and 1205-5**, replace “THERMOPLASTIC” in the title of these tables with “POLYUREA”.

**Page 12-9, Subarticle 1205-6(B), line 21**, replace “Table 1205-4” with “Table 1205-6”.

**Page 12-11, Subarticle 1205-8(C), line 25**, replace “Table 1205-5” with “Table 1205-7”.

### Division 15

**Page 15-4, Subarticle 1505-3(F) Backfilling, line 26**, replace “Subarticle 235-4(C)” with “Subarticle 235-3(C)”.

**Page 15-6, Subarticle 1510-3(B), after line 21**, replace the allowable leakage formula with the following:

$$W = LD\sqrt{P} + 148,000$$

**Page 15-6, Subarticle 1510-3(B), line 32**, delete “may be performed concurrently or” and replace with “shall be performed”.

**Page 15-17, Subarticle 1540-3(E), line 27**, delete “Type 1”.

### Division 17

**Page 17-26, line 42, Subarticle 1731-3(D) Termination and Splicing within Interconnect Center**, delete this subarticle.

DE00085

Revise the 2012 Roadway Standard Drawings as follows:

**1633.01 Sheet 1 of 1, English Standard Drawing for Matting Installation**, replace “1633.01” with “1631.01”.

### **MINIMUM WAGES**

(7-21-09)

Z-5

**FEDERAL:** The Fair Labor Standards Act provides that with certain exceptions every employer shall pay wages at the rate of not less than SEVEN DOLLARS AND TWENTY FIVE CENTS (\$7.25) per hour.

**STATE:** The North Carolina Minimum Wage Act provides that every employer shall pay to each of his employees, wages at a rate of not less than SEVEN DOLLARS AND TWENTY FIVE CENTS (\$7.25) per hour.

The minimum wage paid to all skilled labor employed on this contract shall be SEVEN DOLLARS AND TWENTY FIVE CENTS (\$7.25) per hour.

The minimum wage paid to all intermediate labor employed on this contract shall be SEVEN DOLLARS AND TWENTY FIVE CENTS (\$7.25) per hour.

The minimum wage paid to all unskilled labor on this contract shall be SEVEN DOLLARS AND TWENTY FIVE CENTS (\$7.25) per hour.

This determination of the intent of the application of this act to the contract on this project is the responsibility of the Contractor.

The Contractor shall have no claim against the Department of Transportation for any changes in the minimum wage laws, Federal or State. It is the responsibility of the Contractor to keep fully informed of all Federal and State Laws affecting his contract.

### **ON-THE-JOB TRAINING**

(10-16-07) (Rev. 5-21-13)

Z-10

#### **Description**

The North Carolina Department of Transportation will administer a custom version of the Federal On-the-Job Training (OJT) Program, commonly referred to as the Alternate OJT Program. All contractors (existing and newcomers) will be automatically placed in the Alternate Program. Standard OJT requirements typically associated with individual projects will no longer be applied at the project level. Instead, these requirements will be applicable on an annual basis for each contractor administered by the OJT Program Manager.

On the Job Training shall meet the requirements of 23 CFR 230.107 (b), 23 USC – Section 140, this provision and the On-the-Job Training Program Manual.

The Alternate OJT Program will allow a contractor to train employees on Federal, State and privately funded projects located in North Carolina. However, priority shall be given to training employees on NCDOT Federal-Aid funded projects.

#### **Minorities and Women**

Developing, training and upgrading of minorities and women toward journeyman level status is a primary objective of this special training provision. Accordingly, the Contractor shall make every effort to enroll minority and women as trainees to the extent that such persons are available within a reasonable area of recruitment. This training commitment is not intended, and shall not be used, to discriminate against any applicant for training, whether a member of a minority group or not.

**Assigning Training Goals**

The Department, through the OJT Program Manager, will assign training goals for a calendar year based on the contractors' past three years' activity and the contractors' anticipated upcoming year's activity with the Department. At the beginning of each year, all contractors eligible will be contacted by the Department to determine the number of trainees that will be assigned for the upcoming calendar year. At that time the Contractor shall enter into an agreement with the Department to provide a self-imposed on-the-job training program for the calendar year. This agreement will include a specific number of annual training goals agreed to by both parties. The number of training assignments may range from 1 to 15 per contractor per calendar year. The Contractor shall sign an agreement to fulfill their annual goal for the year. A sample agreement is available at [www.ncbowd.com/section/on-the-job-training](http://www.ncbowd.com/section/on-the-job-training).

**Training Classifications**

The Contractor shall provide on-the-job training aimed at developing full journeyman level workers in the construction craft/operator positions. Preference shall be given to providing training in the following skilled work classifications:

Equipment Operators	Office Engineers
Truck Drivers	Estimators
Carpenters	Iron / Reinforcing Steel Workers
Concrete Finishers	Mechanics
Pipe Layers	Welders

The Department has established common training classifications and their respective training requirements that may be used by the contractors. However, the classifications established are not all-inclusive. Where the training is oriented toward construction applications, training will be allowed in lower-level management positions such as office engineers and estimators. Contractors shall submit new classifications for specific job functions that their employees are performing. The Department will review and recommend for acceptance to FHWA the new classifications proposed by contractors, if applicable. New classifications shall meet the following requirements:

Proposed training classifications are reasonable and realistic based on the job skill classification needs, and

The number of training hours specified in the training classification is consistent with common practices and provides enough time for the trainee to obtain journeyman level status.

The Contractor may allow trainees to be trained by a subcontractor provided that the Contractor retains primary responsibility for meeting the training and this provision is made applicable to the subcontract. However, only the Contractor will receive credit towards the annual goal for the trainee.

Where feasible, 25 percent of apprentices or trainees in each occupation shall be in their first year of apprenticeship or training. The number of trainees shall be distributed among the work classifications on the basis of the contractor's needs and the availability of journeymen in the various classifications within a reasonable area of recruitment.

No employee shall be employed as a trainee in any classification in which they have successfully completed a training course leading to journeyman level status or in which they have been employed as a journeyman.

**Records and Reports**

The Contractor shall maintain enrollment, monthly and completion reports documenting company compliance under these contract documents. These documents and any other information as requested shall be submitted to the OJT Program Manager.

Upon completion and graduation of the program, the Contractor shall provide each trainee with a certification Certificate showing the type and length of training satisfactorily completed.

DE00085

**Trainee Interviews**

All trainees enrolled in the program will receive an initial and Trainee/Post graduate interview conducted by the OJT program staff.

**Trainee Wages**

Contractors shall compensate trainees on a graduating pay scale based upon a percentage of the prevailing minimum journeyman wages (Davis-Bacon Act). Minimum pay shall be as follows:

60 percent	of the journeyman wage for the first half of the training period
75 percent	of the journeyman wage for the third quarter of the training period
90 percent	of the journeyman wage for the last quarter of the training period

In no instance shall a trainee be paid less than the local minimum wage. The Contractor shall adhere to the minimum hourly wage rate that will satisfy both the NC Department of Labor (NCDOL) and the Department.

**Achieving or Failing to Meet Training Goals**

The Contractor will be credited for each trainee employed by him on the contract work who is currently enrolled or becomes enrolled in an approved program and who receives training for at least 50 percent of the specific program requirement. Trainees will be allowed to be transferred between projects if required by the Contractor's scheduled workload to meet training goals.

If a contractor fails to attain their training assignments for the calendar year, they may be taken off the NCDOT's Bidders List.

**Measurement and Payment**

No compensation will be made for providing required training in accordance with these contract documents.

## LISTING OF MBE & WBE SUBCONTRACTORS

Sheet \_\_\_\_\_ of \_\_\_\_\_

FIRM NAME AND ADDRESS	MBE or WBE	ITEM NO.	ITEM DESCRIPTION	* AGREED UPON UNIT PRICE	** DOLLAR VOLUME OF ITEM

\* The Dollar Volume shown in this column shall be the Actual Price Agreed Upon by the Prime Contractor and the MBE and/or WBE subcontractor, and these prices will be used to determine the percentage of the MBE and/or WBE participation in the contract.

\*\* Must have entry even if figure to be entered is zero.

\*\* Dollar Volume of MBE Subcontractor    \$ \_\_\_\_\_  
 MBE Percentage of Total Contract Bid Price    \_\_\_\_\_ %  
 \*\* Dollar Volume of WBE Subcontractor    \$ \_\_\_\_\_  
 WBE Percentage of Total Contract Bid Price    \_\_\_\_\_ %

**This form must be completed in order for the Bid to be considered responsive and be publicly read. Bidders with no MBE and/or WBE participation must so indicate this on the form by entering the word or number *zero*.**

Contract No. DE00085

Rev. 5-19-11

County Wake

**\*AWARD LIMITS ON MULTIPLE PROJECTS\***

It is the desire of the Proposer to be awarded contracts, the value of which will not exceed a total of \$ \_\_\_\_\_, for those projects indicated below on which bids are being opened on the same date as shown in the Proposal Form. Individual projects shall be indicated by placing the project number and county in the appropriate place below. Projects not selected will not be subject to an award limit.

\_\_\_\_\_  
(Project Number)

\_\_\_\_\_  
(County)

\_\_\_\_\_  
(Project Number)

\_\_\_\_\_  
(County)

\_\_\_\_\_  
(Project Number)

\_\_\_\_\_  
(County)

\_\_\_\_\_  
(Project Number)

\_\_\_\_\_  
(County)

\*If a Proposer desires to limit the total amount of work awarded to him in this letting, he shall state such limit in the space provided above in the second line of this form.

It is agreed that in the event that I am (we are) the successful bidder on indicated projects, the total value of which is more that the above stipulated award limits, the Board of Transportation will award me (us) projects from among those indicated which have a total value not exceeding the award limit and which will result in the best advantage to the Department of Transportation.

\_\_\_\_\_  
\*\*Signature of Authorized Person

\*\*Only those persons authorized to sign bids under the provisions of Article 102-8, Item 7, shall be authorized to sign this form.

Contract No. DE00085

Rev. 5-19-11

County Wake



County : Wake

Line #	Item Number	Sec #	Description	Quantity	Unit Cost	Amount
<b>ROADWAY ITEMS</b>						
0001	0000100000-N	800	MOBILIZATION	Lump Sum	L.S.	
0002	0000400000-N	801	CONSTRUCTION SURVEYING	Lump Sum	L.S.	
0003	0030000000-N	SP	BRIDGE APPROACH FILL - SUB REGIONAL TIER, STATION ***** STA. 13+70.00	Lump Sum	L.S.	
0004	0043000000-N	226	GRADING	Lump Sum	L.S.	
0005	0050000000-E	226	SUPPLEMENTARY CLEARING & GRUB-BING	1 ACR		
0006	0057000000-E	226	UNDERCUT EXCAVATION	100 CY		
0007	0196000000-E	270	GEOTEXTILE FOR SOIL STABILIZATION	400 SY		
0008	0318000000-E	300	FOUNDATION CONDITIONING MATERIAL, MINOR STRUCTURES	10 TON		
0009	0320000000-E	300	FOUNDATION CONDITIONING GEOTEXTILE	20 SY		
0010	0335200000-E	305	15" DRAINAGE PIPE	24 LF		
0011	0448200000-E	310	15" RC PIPE CULVERTS, CLASS IV	32 LF		
0012	1099700000-E	505	CLASS IV SUBGRADE STABILIZATION	100 TON		
0013	1220000000-E	545	INCIDENTAL STONE BASE	50 TON		
0014	1489000000-E	610	ASPHALT CONC BASE COURSE, TYPE B25.0B	330 TON		
0015	1498000000-E	610	ASPHALT CONC INTERMEDIATE COURSE, TYPE I19.0B	280 TON		
0016	1525000000-E	610	ASPHALT CONC SURFACE COURSE, TYPE SF9.5A	220 TON		
0017	1575000000-E	620	ASPHALT BINDER FOR PLANT MIX	45 TON		
0018	2000000000-N	806	RIGHT OF WAY MARKERS	8 EA		



County : Wake

Line #	Item Number	Sec #	Description	Quantity	Unit Cost	Amount
0019	2022000000-E	815	SUBDRAIN EXCAVATION	23 CY		
0020	2026000000-E	815	GEOTEXTILE FOR SUBSURFACE DRAINS	100 SY		
0021	2036000000-E	815	SUBDRAIN COARSE AGGREGATE	17 CY		
0022	2044000000-E	815	6" PERFORATED SUBDRAIN PIPE	100 LF		
0023	2070000000-N	815	SUBDRAIN PIPE OUTLET	1 EA		
0024	2077000000-E	815	6" OUTLET PIPE	6 LF		
0025	2286000000-N	840	MASONRY DRAINAGE STRUCTURES	2 EA		
0026	2367000000-N	840	FRAME WITH TWO GRATES, STD 840.29	2 EA		
0027	2556000000-E	846	SHOULDER BERM GUTTER	82 LF		
0028	3030000000-E	862	STEEL BM GUARDRAIL	100 LF		
0029	3150000000-N	862	ADDITIONAL GUARDRAIL POSTS	5 EA		
0030	3215000000-N	862	GUARDRAIL ANCHOR UNITS, TYPE III	4 EA		
0031	3270000000-N	SP	GUARDRAIL ANCHOR UNITS, TYPE 350	4 EA		
0032	3635000000-E	876	RIP RAP, CLASS II	704 TON		
0033	3642000000-E	876	RIP RAP, CLASS A	63 TON		
0034	3649000000-E	876	RIP RAP, CLASS B	1 TON		
0035	3656000000-E	876	GEOTEXTILE FOR DRAINAGE	2,206 SY		
0036	4399000000-N	1105	TEMPORARY TRAFFIC CONTROL	Lump Sum	L.S.	
0037	4422000000-N	1120	PORTABLE CHANGEABLE MESSAGE SIGN (SHORT TERM)	14 DAY		



County : Wake

Line #	Item Number	Sec #	Description	Quantity	Unit Cost	Amount
0038	4685000000-E	1205	THERMOPLASTIC PAVEMENT MARKING LINES (4", 90 MILS)	1,080	LF	
0039	4686000000-E	1205	THERMOPLASTIC PAVEMENT MARKING LINES (4", 120 MILS)	1,080	LF	
0040	6000000000-E	1605	TEMPORARY SILT FENCE	1,545	LF	
0041	6006000000-E	1610	STONE FOR EROSION CONTROL, CLASS A	115	TON	
0042	6009000000-E	1610	STONE FOR EROSION CONTROL, CLASS B	5	TON	
0043	6012000000-E	1610	SEDIMENT CONTROL STONE	315	TON	
0044	6015000000-E	1615	TEMPORARY MULCHING	0.5	ACR	
0045	6018000000-E	1620	SEED FOR TEMPORARY SEEDING	50	LB	
0046	6021000000-E	1620	FERTILIZER FOR TEMPORARY SEEDING	0.25	TON	
0047	6024000000-E	1622	TEMPORARY SLOPE DRAINS	200	LF	
0048	6029000000-E	SP	SAFETY FENCE	100	LF	
0049	6030000000-E	1630	SILT EXCAVATION	10	CY	
0050	6036000000-E	1631	MATTING FOR EROSION CONTROL	750	SY	
0051	6037000000-E	SP	COIR FIBER MAT	150	SY	
0052	6042000000-E	1632	1/4" HARDWARE CLOTH	220	LF	
0053	6048000000-E	SP	FLOATING TURBIDITY CURTAIN	200	SY	
0054	6070000000-N	1639	SPECIAL STILLING BASINS	12	EA	
0055	6071012000-E	SP	COIR FIBER WATTLE	60	LF	
0056	6084000000-E	1660	SEEDING & MULCHING	0.5	ACR	
0057	6087000000-E	1660	MOWING	0.5	ACR	



County : Wake

Line #	Item Number	Sec #	Description	Quantity	Unit Cost	Amount
0058	6090000000-E	1661	SEED FOR REPAIR SEEDING	50 LB		
0059	6093000000-E	1661	FERTILIZER FOR REPAIR SEEDING	0.25 TON		
0060	6096000000-E	1662	SEED FOR SUPPLEMENTAL SEEDING	50 LB		
0061	6108000000-E	1665	FERTILIZER TOPDRESSING	0.25 TON		
0062	6114500000-N	1667	SPECIALIZED HAND MOWING	10 MHR		
0063	6117000000-N	SP	RESPONSE FOR EROSION CONTROL	25 EA		
0064	6123000000-E	1670	REFORESTATION	0.1 ACR		
0065	8035000000-N	402	REMOVAL OF EXISTING STRUCTURE AT STATION ***** STA. 13+70.00	Lump Sum	L.S.	
0066	8096000000-E	450	PILE EXCAVATION IN SOIL	47 LF		
0067	8097000000-E	450	PILE EXCAVATION NOT IN SOIL	23 LF		
0068	8105520000-E	411	3'-0" DIA DRILLED PIERS IN SOIL	33.8 LF		
0069	8105620000-E	411	3'-0" DIA DRILLED PIERS NOT IN SOIL	55 LF		
0070	8111200000-E	411	PERMANENT STEEL CASING FOR 3'-0" DIA DRILLED PIER	46.8 LF		
0071	8113000000-N	411	SID INSPECTIONS	1 EA		
0072	8114000000-N	411	SPT TESTING	1 EA		
0073	8115000000-N	411	CSL TESTING	1 EA		
0074	8121000000-N	412	UNCLASSIFIED STRUCTURE EXCAVA- TION AT STATION ***** STA. 13+70.00	Lump Sum	L.S.	
0075	8182000000-E	420	CLASS A CONCRETE (BRIDGE)	76.5 CY		





County : Wake

Line #	Item Number	Sec #	Description	Quantity	Unit Cost	Amount
0076	8210000000-N	422	BRIDGE APPROACH SLABS, STATION ***** STA. 13+70.00	Lump Sum	L.S.	
0077	8217000000-E	425	REINFORCING STEEL (BRIDGE)	19,804 LB		
0078	8238000000-E	425	SPIRAL COLUMN REINFORCING STEEL (BRIDGE)	1,943 LB		
0079	8364000000-E	450	HP12X53 STEEL PILES	195 LF		
0080	8391000000-N	450	STEEL PILE POINTS	14 EA		
0081	8505000000-E	460	VERTICAL CONCRETE BARRIER RAIL	260.5 LF		
0082	8608000000-E	876	RIP RAP CLASS II (2'-0" THICK)	540 TON		
0083	8657000000-N	430	ELASTOMERIC BEARINGS	Lump Sum	L.S.	
0084	8762000000-E	430	3'-0" X 1'-9" PRESTRESSED CONC CORED SLABS	1,560 LF		

1615/Dec19/Q35693.95/D393655452000/E84

Total Amount Of Bid For Entire Project :

Contract No. DE00085

Rev. 5-19-11

County Wake

County Wake

PLEASE ACKNOWLEDGE RECEIPT OF ADDENDA BY WRITING IN ADDENDUM NUMBER, INITIALING AND DATING BELOW.

Addendum No. \_\_\_\_\_ Initial & Date: \_\_\_\_\_ Addendum No. \_\_\_\_\_ Initial & Date: \_\_\_\_\_

CONTRACTOR: \_\_\_\_\_

ADDRESS: \_\_\_\_\_

Federal Identification Number: \_\_\_\_\_

Authorized Agent: \_\_\_\_\_ Title: \_\_\_\_\_

Signature: \_\_\_\_\_ Date: \_\_\_\_\_

Witness: \_\_\_\_\_ Title: \_\_\_\_\_

Signature: \_\_\_\_\_ Date: \_\_\_\_\_

---

**THIS SECTION TO BE COMPLETED BY N. C. DEPARTMENT OF TRANSPORTATION**  
*This bid has been reviewed in accordance with Article 103-1 of the Standard Specifications for Roads and Structures 2012.*

*Reviewed by:* \_\_\_\_\_  
DATE

*Accepted by NCDOT:* \_\_\_\_\_  
DATE

Contract No. DE00085

Rev. 5-19-11

County Wake

County Wake

**EXECUTION OF CONTRACT  
NON-COLLUSION AFFIDAVIT, DEBARMENT CERTIFICATION AND GIFT BAN CERTIFICATION  
CORPORATION**

The Contractor being duly sworn, solemnly swears (or affirms) that neither he, nor any official, agent or employee has entered into any agreement, participated in any collusion, or otherwise taken any action which is in restraint of free competitive bidding in connection with this Contract, that the Contractor has not been convicted of violating *N.C.G.S. § 133-24* within the last three years, and that the Contractor intends to do the work with its own bonafide employees or subcontractors and did not bid for the benefit of another contractor.

By submitting this Execution of Contract, Non-Collusion Affidavit and Debarment Certification, the Contractor is certifying his status under penalty of perjury under the laws of the United States in accordance with the Debarment Certification attached, provided that the Debarment Certification also includes any required statements concerning exceptions that are applicable.

*N.C.G.S. § 133-32* and Executive Order 24 prohibit the offer to, or acceptance by, any State Employee of any gift from anyone with a contract with the State, or from any person seeking to do business with the State. By execution of any response in this procurement, you attest, for your entire organization and its employees or agents, that you are not aware that any such gift has been offered, accepted, or promised by any employees of your organization.

**SIGNATURE OF CONTRACTOR**

\_\_\_\_\_  
Full name of Corporation

\_\_\_\_\_  
Address as Prequalified

Attest \_\_\_\_\_  
Secretary/Assistant Secretary  
*Select appropriate title*

By \_\_\_\_\_  
President/Vice President/Assistant Vice President  
*Select appropriate title*

\_\_\_\_\_  
Print or type Signer's name

\_\_\_\_\_  
Print or type Signer's name

**CORPORATE SEAL**

**AFFIDAVIT MUST BE NOTARIZED**

Subscribed and sworn to before me this the  
\_\_\_\_\_ day of \_\_\_\_\_ 20\_\_.

\_\_\_\_\_  
Signature of Notary Public

**NOTARY SEAL**

of \_\_\_\_\_ County

State of \_\_\_\_\_

My Commission Expires: \_\_\_\_\_

Contract No. DE00085

Rev. 5-19-11

County Wake

County Wake

**EXECUTION OF CONTRACT  
NON-COLLUSION AFFIDAVIT, DEBARMENT CERTIFICATION AND GIFT BAN CERTIFICATION  
PARTNERSHIP**

The Contractor being duly sworn, solemnly swears (or affirms) that neither he, nor any official, agent or employee has entered into any agreement, participated in any collusion, or otherwise taken any action which is in restraint of free competitive bidding in connection with this Contract, that the Contractor has not been convicted of violating *N.C.G.S. § 133-24* within the last three years, and that the Contractor intends to do the work with its own bonafide employees or subcontractors and did not bid for the benefit of another contractor.

By submitting this Execution of Contract, Non-Collusion Affidavit and Debarment Certification, the Contractor is certifying his status under penalty of perjury under the laws of the United States in accordance with the Debarment Certification attached, provided that the Debarment Certification also includes any required statements concerning exceptions that are applicable.

*N.C.G.S. § 133-32* and Executive Order 24 prohibit the offer to, or acceptance by, any State Employee of any gift from anyone with a contract with the State, or from any person seeking to do business with the State. By execution of any response in this procurement, you attest, for your entire organization and its employees or agents, that you are not aware that any such gift has been offered, accepted, or promised by any employees of your organization.

**SIGNATURE OF CONTRACTOR**

\_\_\_\_\_ Full Name of Partnership

\_\_\_\_\_ Address as Prequalified

\_\_\_\_\_ By \_\_\_\_\_  
Signature of Witness Signature of Partner

\_\_\_\_\_ Print or type Signer's name

\_\_\_\_\_ Print or type Signer's name

**AFFIDAVIT MUST BE NOTARIZED**

Subscribed and sworn to before me this the

**NOTARY SEAL**

\_\_\_\_\_ day of \_\_\_\_\_ 20\_\_.

\_\_\_\_\_ Signature of Notary Public

of \_\_\_\_\_ County

State of \_\_\_\_\_

My Commission Expires: \_\_\_\_\_

Contract No. DE00085

Rev. 5-19-11

County Wake



County Wake

**EXECUTION OF CONTRACT  
NON-COLLUSION AFFIDAVIT, DEBARMENT CERTIFICATION AND GIFT BAN CERTIFICATION  
LIMITED LIABILITY COMPANY**

The Contractor being duly sworn, solemnly swears (or affirms) that neither he, nor any official, agent or employee has entered into any agreement, participated in any collusion, or otherwise taken any action which is in restraint of free competitive bidding in connection with this Contract, that the Contractor has not been convicted of violating *N.C.G.S. § 133-24* within the last three years, and that the Contractor intends to do the work with its own bonafide employees or subcontractors and did not bid for the benefit of another contractor.

By submitting this Execution of Contract, Non-Collusion Affidavit and Debarment Certification, the Contractor is certifying his status under penalty of perjury under the laws of the United States in accordance with the Debarment Certification attached, provided that the Debarment Certification also includes any required statements concerning exceptions that are applicable.

*N.C.G.S. § 133-32* and Executive Order 24 prohibit the offer to, or acceptance by, any State Employee of any gift from anyone with a contract with the State, or from any person seeking to do business with the State. By execution of any response in this procurement, you attest, for your entire organization and its employees or agents, that you are not aware that any such gift has been offered, accepted, or promised by any employees of your organization.

**SIGNATURE OF CONTRACTOR**

\_\_\_\_\_  
Full Name of Firm

\_\_\_\_\_  
Address as Prequalified

\_\_\_\_\_  
Signature of Witness

\_\_\_\_\_  
Signature of Member/Manager/Authorized Agent  
*Select appropriate title*

\_\_\_\_\_  
Print or type Signer's name

\_\_\_\_\_  
Print or type Signer's Name

**AFFIDAVIT MUST BE NOTARIZED**

Subscribed and sworn to before me this the \_\_\_\_\_  
\_\_\_\_\_ day of \_\_\_\_\_ 20\_\_.

**NOTARY SEAL**

\_\_\_\_\_  
Signature of Notary Public

of \_\_\_\_\_ County

State of \_\_\_\_\_

My Commission Expires: \_\_\_\_\_

Contract No. DE00085

Rev. 5-19-11

County Wake

County Wake

**EXECUTION OF CONTRACT  
NON-COLLUSION AFFIDAVIT, DEBARMENT CERTIFICATION AND GIFT BAN CERTIFICATION  
JOINT VENTURE (2) or (3)**

The Contractor being duly sworn, solemnly swears (or affirms) that neither he, nor any official, agent or employee has entered into any agreement, participated in any collusion, or otherwise taken any action which is in restraint of free competitive bidding in connection with this Contract, that the Contractor has not been convicted of violating *N.C.G.S. § 133-24* within the last three years, and that the Contractor intends to do the work with its own bonafide employees or subcontractors and did not bid for the benefit of another contractor.

By submitting this Execution of Contract, Non-Collusion Affidavit and Debarment Certification, the Contractor is certifying his status under penalty of perjury under the laws of the United States in accordance with the Debarment Certification attached, provided that the Debarment Certification also includes any required statements concerning exceptions that are applicable.

*N.C.G.S. § 133-32* and Executive Order 24 prohibit the offer to, or acceptance by, any State Employee of any gift from anyone with a contract with the State, or from any person seeking to do business with the State. By execution of any response in this procurement, you attest, for your entire organization and its employees or agents, that you are not aware that any such gift has been offered, accepted, or promised by any employees of your organization.

**SIGNATURE OF CONTRACTORS**

Instructions: **2 Joint Venturers** Fill in lines (1), (2) and (3) and execute. **3 Joint Venturers** Fill in lines (1), (2), (3) and (4) and execute. On Line (1), fill in the name of the Joint Venture Company. On Line (2), fill in the name of one of the joint venturers and execute below in the appropriate manner. On Line (3), print or type the name of the other joint venturer and execute below in the appropriate manner. On Line (4), fill in the name of the third joint venturer, if applicable and execute below in the appropriate manner.

(1) \_\_\_\_\_  
Name of Joint Venture

(2) \_\_\_\_\_  
Name of Contractor

\_\_\_\_\_ Address as Prequalified

_____ Signature of Witness or Attest	By	_____ Signature of Contractor
_____ Print or type Signer's name		_____ Print or type Signer's name

*If Corporation, affix Corporate Seal* and

(3) \_\_\_\_\_  
Name of Contractor

\_\_\_\_\_ Address as Prequalified

_____ Signature of Witness or Attest	By	_____ Signature of Contractor
_____ Print or type Signer's name		_____ Print or type Signer's name

*If Corporation, affix Corporate Seal* and

(4) \_\_\_\_\_  
Name of Contractor (for 3 Joint Venture only)

\_\_\_\_\_ Address as Prequalified

_____ Signature of Witness or Attest	By	_____ Signature of Contractor
_____ Print or type Signer's name		_____ Print or type Signer's name

*If Corporation, affix Corporate Seal*

**NOTARY SEAL**  
Affidavit must be notarized for Line (2)  
Subscribed and sworn to before me this \_\_\_\_\_ day of \_\_\_\_\_ 20\_\_\_\_  
\_\_\_\_\_  
Signature of Notary Public  
of \_\_\_\_\_ County  
State of \_\_\_\_\_  
My Commission Expires: \_\_\_\_\_

**NOTARY SEAL**  
Affidavit must be notarized for Line (3)  
Subscribed and sworn to before me this \_\_\_\_\_ day of \_\_\_\_\_ 20\_\_\_\_  
\_\_\_\_\_  
Signature of Notary Public  
of \_\_\_\_\_ County  
State of \_\_\_\_\_  
My Commission Expires: \_\_\_\_\_

**NOTARY SEAL**  
Affidavit must be notarized for Line (4)  
Subscribed and sworn to before me this \_\_\_\_\_ day of \_\_\_\_\_ 20\_\_\_\_  
\_\_\_\_\_  
Signature of Notary Public  
of \_\_\_\_\_ County  
State of \_\_\_\_\_  
My Commission Expires: \_\_\_\_\_

Contract No. DE00085

Rev. 5-19-11

County Wake

County Wake

**EXECUTION OF CONTRACT  
NON-COLLUSION AFFIDAVIT, DEBARMENT CERTIFICATION AND GIFT BAN CERTIFICATION  
INDIVIDUAL DOING BUSINESS UNDER A FIRM NAME**

The Contractor being duly sworn, solemnly swears (or affirms) that neither he, nor any official, agent or employee has entered into any agreement, participated in any collusion, or otherwise taken any action which is in restraint of free competitive bidding in connection with this Contract, that the Contractor has not been convicted of violating *N.C.G.S. § 133-24* within the last three years, and that the Contractor intends to do the work with its own bonafide employees or subcontractors and did not bid for the benefit of another contractor.

By submitting this Execution of Contract, Non-Collusion Affidavit and Debarment Certification, the Contractor is certifying his status under penalty of perjury under the laws of the United States in accordance with the Debarment Certification attached, provided that the Debarment Certification also includes any required statements concerning exceptions that are applicable.

*N.C.G.S. § 133-32* and Executive Order 24 prohibit the offer to, or acceptance by, any State Employee of any gift from anyone with a contract with the State, or from any person seeking to do business with the State. By execution of any response in this procurement, you attest, for your entire organization and its employees or agents, that you are not aware that any such gift has been offered, accepted, or promised by any employees of your organization.

**SIGNATURE OF CONTRACTOR**

Name of Contractor

\_\_\_\_\_ Individual name

Trading and doing business as

\_\_\_\_\_ Full name of Firm

\_\_\_\_\_ Address as Prequalified

\_\_\_\_\_ Signature of Witness

\_\_\_\_\_ Signature of Contractor, Individually

\_\_\_\_\_ Print or type Signer's name

\_\_\_\_\_ Print or type Signer's name

**AFFIDAVIT MUST BE NOTARIZED**

Subscribed and sworn to before me this the

**NOTARY SEAL**

\_\_\_\_\_ day of \_\_\_\_\_ 20\_\_.

\_\_\_\_\_ Signature of Notary Public

of \_\_\_\_\_ County

State of \_\_\_\_\_

My Commission Expires: \_\_\_\_\_

Contract No. DE00085

Rev. 5-19-11

County Wake

County Wake

**EXECUTION OF CONTRACT  
NON-COLLUSION AFFIDAVIT, DEBARMENT CERTIFICATION AND GIFT BAN CERTIFICATION  
INDIVIDUAL DOING BUSINESS IN HIS OWN NAME**

The Contractor being duly sworn, solemnly swears (or affirms) that neither he, nor any official, agent or employee has entered into any agreement, participated in any collusion, or otherwise taken any action which is in restraint of free competitive bidding in connection with this Contract, that the Contractor has not been convicted of violating *N.C.G.S. § 133-24* within the last three years, and that the Contractor intends to do the work with its own bonafide employees or subcontractors and did not bid for the benefit of another contractor.

By submitting this Execution of Contract, Non-Collusion Affidavit and Debarment Certification, the Contractor is certifying his status under penalty of perjury under the laws of the United States in accordance with the Debarment Certification attached, provided that the Debarment Certification also includes any required statements concerning exceptions that are applicable.

*N.C.G.S. § 133-32* and Executive Order 24 prohibit the offer to, or acceptance by, any State Employee of any gift from anyone with a contract with the State, or from any person seeking to do business with the State. By execution of any response in this procurement, you attest, for your entire organization and its employees or agents, that you are not aware that any such gift has been offered, accepted, or promised by any employees of your organization.

**SIGNATURE OF CONTRACTOR**

Name of Contractor \_\_\_\_\_  
Print or type Individual name

\_\_\_\_\_  
Address as Prequalified

\_\_\_\_\_  
Signature of Contractor, Individually

\_\_\_\_\_  
Print or type Signer's Name

\_\_\_\_\_  
Signature of Witness

\_\_\_\_\_  
Print or type Signer's name

**AFFIDAVIT MUST BE NOTARIZED**

Subscribed and sworn to before me this the \_\_\_\_\_  
\_\_\_\_\_ day of \_\_\_\_\_ 20\_\_.

**NOTARY SEAL**

\_\_\_\_\_  
Signature of Notary Public

of \_\_\_\_\_ County

State of \_\_\_\_\_

My Commission Expires: \_\_\_\_\_

Contract No. DE00085

Rev. 5-19-11

County Wake



## DEBARMENT CERTIFICATION

### Conditions for certification:

1. The prequalified bidder shall provide immediate written notice to the Department if at any time the bidder learns that his certification was erroneous when he submitted his debarment certification or explanation filed with the Department, or has become erroneous because of changed circumstances.
2. The terms *covered transaction, debarred, suspended, ineligible, lower tier covered transaction, participant, person, primary covered transaction, principal, proposal, and voluntarily excluded*, as used in this provision, have the meanings set out in the Definitions and Coverage sections of the rules implementing Executive Order 12549. A copy of the Federal Rules requiring this certification and detailing the definitions and coverages may be obtained from the Contract Officer of the Department.
3. The prequalified bidder agrees by submitting this form, that he will not knowingly enter into any lower tier covered transaction with a person who is debarred, suspended, declared ineligible, or voluntarily excluded from participation in NCDOT contracts, unless authorized by the Department.
4. For Federal Aid projects, the prequalified bidder further agrees that by submitting this form he will include the Federal-Aid Provision titled *Required Contract Provisions Federal-Aid Construction Contract (Form FHWA PR 1273)* provided by the Department, without subsequent modification, in all lower tier covered transactions.
5. The prequalified bidder may rely upon a certification of a participant in a lower tier covered transaction that he is not debarred, suspended, ineligible, or voluntarily excluded from the covered transaction, unless he knows that the certification is erroneous. The bidder may decide the method and frequency by which he will determine the eligibility of his subcontractors.
6. Nothing contained in the foregoing shall be construed to require establishment of a system of records in order to render in good faith the certification required by this provision. The knowledge and information of a participant is not required to exceed that which is normally possessed by a prudent person in the ordinary course of business dealings.
7. Except as authorized in paragraph 6 herein, the Department may terminate any contract if the bidder knowingly enters into a lower tier covered transaction with a person who is suspended, debarred, ineligible, or voluntarily excluded from participation in this transaction, in addition to other remedies available by the Federal Government.

Contract No. DE00085

Rev. 5-19-11

County Wake

County Wake

**DEBARMENT CERTIFICATION**

The prequalified bidder certifies to the best of his knowledge and belief, that he and his principals:

- a. Are not presently debarred, suspended, proposed for debarment, declared ineligible, or voluntarily excluded from covered transactions by any Federal department or agency;
- b. Have not within a three-year period preceding this proposal been convicted of or had a civil judgment rendered against them for commission of fraud or a criminal offense in connection with obtaining, attempting to obtain, or performing a public (Federal, State or local) transaction or contract under a public transaction; violation of Federal or State antitrust statutes or commission of embezzlement, theft, forgery, bribery, falsification or destruction of records; making false statements; or receiving stolen property;
- c. Are not presently indicted for or otherwise criminally or civilly charged by a governmental entity (Federal, State or local) with commission of any of the offenses enumerated in paragraph b. of this certification; and
- d. Have not within a three-year period preceding this proposal had one or more public transactions (Federal, State or local) terminated for cause or default.
- e. Will submit a revised Debarment Certification immediately if his status changes and will show in his bid proposal an explanation for the change in status.

If the prequalified bidder cannot certify that he is not debarred, he shall provide an explanation with this submittal. An explanation will not necessarily result in denial of participation in a contract.

Failure to submit a non-collusion affidavit and debarment certification will result in the prequalified bidder's bid being considered non-responsive.

Check here if an explanation is attached to this certification.



2/16/99

**Contract No: DE00085**

**County: Wake**

ACCEPTED BY THE  
DEPARTMENT OF TRANSPORTATION

---

Contract Officer

---

Date

Signature Sheet 7 (Bid - Acceptance by Department)



## **GEOTECHNICAL ATTACHMENT 'A'**

**The following Geotechnical Bore Holes Sections are for information only and are not a part of this contract. This information is for investigation only and no accuracy is implied or guaranteed. No claim will be allowed as a result of the use of this information.**



STATE OF NORTH CAROLINA  
DEPARTMENT OF TRANSPORTATION

BEVERLY EAVES PERDUE  
GOVERNOR

EUGENE A. CONTI, JR.  
SECRETARY

September 24, 2012

MEMORANDUM TO: J. Wally Bowman, P.E.  
Division 5 Engineer

ATTENTION: Mark Craig, P.E.  
Division Bridge Program Manager

FROM: *CAK* Kyung (K. J.) Kim, Ph.D., P.E.  
Eastern Regional Geotechnical Manager

STATE PROJECT: 17BP.5.R.35 (SF-910201)  
FEDERAL PROJECT: N/A  
COUNTY: Wake

DESCRIPTION: Bridge No. 201 on SR 2368 over Little River  
Between SR 2407 and SR 2450

SUBJECT: Bridge Foundation Recommendations

The Geotechnical Engineering Unit has completed the subsurface investigation and has prepared the foundation design recommendations for the above structure and presents the following project data:

- Bridge Inventory (14) pages
- Foundation Design Recommendations (5) pages
- Design Calculations ( ) pages
- Special Provisions ( ) pages

Please call Nadia Al-Dhalimy, P.E. or Chris Kreider, P.E. at (919) 662-4710 if there are any questions concerning this memorandum.

KJK/CAK/NAA

MAILING ADDRESS:  
EASTERN REGIONAL OFFICE  
GEOTECHNICAL ENGINEERING UNIT  
1570 MAIL SERVICE CENTER  
RALEIGH NC 27699-1570

TELEPHONE: 919-662-4710  
FAX: 919-662-3095

WEBSITE: [WWW.DOH.DOT.STATE.NC.US](http://WWW.DOH.DOT.STATE.NC.US)

LOCATION:  
3301 JONES SAUSAGE RD., SUITE 100  
GARNER, NC 27529-9489



# FOUNDATION RECOMMENDATIONS

PROJECT 17BP.5.R.35

DESCRIPTION Bridge No. 201 on SR 2368

T.I.P. NO. SE-910201

(Green Pace Road) over Little River

COUNTY Wake

between SR 2407 and SR 2450

STATION 13+70.00 -L-

	INITIALS	DATE
DESIGN	NAA	09/12/2012
CHECK	CAK	9/25/12
APPROVAL	CAK	9/25/12

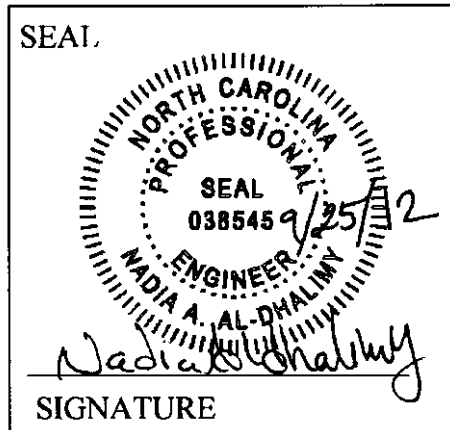

BENT NO.	STATION	FOUNDATION TYPE	FACTORED RESISTANCE	MISCELLANEOUS DETAILS
END BENT 1	13+03.75 -L-	Cap on HP 12 x 53 Steel Piles with Steel H-Pile points	61 Tons/Pile	Bottom of Cap Elevation = 237.65 ft. ± Estimated Pile Length = 10 ft. ± Number of Piles = 7
BENT 1	13+44.94 -L-	36 in. Diameter Drilled Piers	395 Tons/Pier	Bottom of Cap Elevation = 239 ft. ± Estimated Drilled Pier Top El. = 236 ft. ± Point of Fixity Elevation = 224 ft. ± Tip Elevation No Higher Than = 220 ft. Number of Piers = 3
BENT 2	13+95.06 -L-	36 in. Diameter Drilled Piers	395 Tons/Pier	Bottom of Cap Elevation = 239 ft. ± Estimated Drilled Pier Top El. = 236 ft. ± Point of Fixity Elevation = 224 ft. ± Tip Elevation No Higher Than = 221 ft. Number of Piers = 3
END BENT 2	14+36.25 -L-	Cap on HP 12 x 53 Steel Piles with Steel H-Pile points	61 Tons/Pile	Bottom of Cap Elevation = 237.26 ft. ± Estimated Pile Length (L&C) = 15 ft. ± Estimated Pile Length (R) = 10 ft. ± Number of Piles = 7

COMMENTS & NOTES (See Following Page)

**FOUNDATION RECOMMENDATION NOTES ON PLANS**

1. FOR PILES, SEE SECTION 450 OF THE STANDARD SPECIFICATIONS.
2. PILES AT END BENT NO. 1 AND END BENT NO. 2 ARE DESIGNED FOR A FACTORED RESISTANCE OF 61 TONS PER PILE.
3. DRIVE PILES AT END BENT NO. 1 AND END BENT NO. 2 TO A REQUIRED DRIVING RESISTANCE OF 105 TONS PER PILE.
4. STEEL H-PILE POINTS ARE REQUIRED FOR STEEL H-PILES AT END BENT NO. 1 AND END BENT NO. 2. FOR STEEL PILE POINTS, SEE SECTION 450 OF THE STANDARD SPECIFICATIONS.
5. PILE EXCAVATION IS REQUIRED TO INSTALL PILES AT END BENT NO. 1. EXCAVATE HOLES AT PILE LOCATIONS TO ELEVATION 227.6 FT. FOR PILE EXCAVATION, SEE SECTION 450 OF THE STANDARD SPECIFICATIONS.
6. CONCRETE OR GROUT IS REQUIRED TO FILL HOLES FOR PILE EXCAVATION AT END BENT NO. 1.
7. FOR DRILLED PIERS, SEE SECTION 411 OF THE STANDARD SPECIFICATIONS.
8. DRILLED PIERS AT BENT NO. 1 AND BENT NO. 2 ARE DESIGNED FOR A FACTORED RESISTANCE OF 395 TONS PER PIER. CHECK FIELD CONDITIONS FOR THE REQUIRED TIP RESISTANCE OF 40 TSF.
9. INSTALL DRILLED PIERS AT BENT NO. 1 THAT EXTEND TO AN ELEVATION NO HIGHER THAN 220 FT AND SATISFY THE REQUIRED TIP RESISTANCE.
10. INSTALL DRILLED PIERS AT BENT NO. 2 THAT EXTEND TO AN ELEVATION NO HIGHER THAN 221 FT AND SATISFY THE REQUIRED TIP RESISTANCE.
11. PERMANENT STEEL CASINGS ARE REQUIRED FOR DRILLED PIERS AT BENT NO. 1.  
1. DO NOT EXTEND PERMANENT CASINGS BELOW ELEVATIONS 227 FEET (L&C) AND 231 FEET (R) WITHOUT PRIOR APPROVAL FROM THE ENGINEER.
12. PERMANENT STEEL CASINGS ARE REQUIRED FOR DRILLED PIERS AT BENT NO. 2.  
2. DO NOT EXTEND PERMANENT CASINGS BELOW ELEVATIONS 226 FEET (L&C) AND 228 FEET (R) WITHOUT PRIOR APPROVAL FROM THE ENGINEER.
13. THE SCOUR CRITICAL ELEVATION FOR BENT NO. 1 IS ELEVATION 225 FEET. SCOUR CRITICAL ELEVATIONS ARE USED TO MONITOR POSSIBLE SCOUR PROBLEMS DURING THE LIFE OF THE STRUCTURE.

14. THE SCOUR CRITICAL ELEVATION FOR BENT NO. 2 IS ELEVATION 226 FEET. SCOUR CRITICAL ELEVATIONS ARE USED TO MONITOR POSSIBLE SCOUR PROBLEMS DURING THE LIFE OF THE STRUCTURE.
15. SPT MAY BE REQUIRED FOR DRILLED PIERS AT BENT NO. 1 AND BENT NO. 2. FOR SPT TESTING, SEE SECTION 411 OF THE STANDARD SPECIFICATIONS.
16. CSL TUBES ARE REQUIRED AND CSL TESTING MAY BE REQUIRED FOR DRILLED PIERS AT BENT NO.1 AND BENT NO. 2. FOR CSL TESTING, SEE SECTION 411 OF THE STANDARD SPECIFICATIONS.
17. SID INSPECTIONS MAY BE REQUIRED FOR DRILLED PIERS. THE ENGINEER WILL DETERMINE THE NEED FOR SID INSPECTIONS. FOR SID INSPECTIONS, SEE SECTION 411 OF THE STANDARD SPECIFICATIONS.

**FOUNDATION RECOMMENDATION COMMENTS**

1. 1.5:1 (H:V) SLOPES FOR END BENTS WITH SLOPE PROTECTION TO BERM ARE OK.
2. BRACED PILES SHOULD BE CONSIDERED AT END BENT NO. 2 DUE TO THE SHORT PILE LENGTHS.
3. USE APPROACH FILL DETAIL FOR SUB-REGIONAL TIER BRIDGES AT EACH END BENT.
4. DESIGN SCOUR ELEVATION FOR BENT NO. 1 IS 226.8 FEET.
5. DESIGN SCOUR ELEVATION FOR BENT NO. 2 IS 227.7 FEET.
6. NO WAITING PERIOD IS REQUIRED BEFORE BEGINNING ANY WORK FOR END BENT CONSTRUCTION AFTER COMPLETION OF THE EMBANKMENT AT EACH END BENT.

## PILE PAY ITEMS

(Revised 8/15/12)

WBS ELEMENT 17BP.5.R.35

TIP NO. SF-910201

COUNTY Wake

STATION 13+70.00 -L-

DATE 9/12/2012

DESIGNED BY NAA

CHECKED BY (Signature)

DESCRIPTION Bridge No. 201 on SR 2368 over Little Creek  
Between SR 2407 and SR 2450

NUMBER OF BENTS WITH PILES \_\_\_\_\_

NUMBER OF PILES PER BENT \_\_\_\_\_

NUMBER OF END BENTS WITH PILES 1

NUMBER OF PILES PER END BENT 7

Only required for "Predrilling  
for Piles" & "Pile  
Excavation" pay items

Bent # or End Bent #	PILE PAY ITEM QUANTITIES						PDA Testing (per each)
	Steel Pile Points (yes/no)	Pipe Pile Plates (yes/no/maybe)	Predrilling For Piles (per linear ft)	Pile Redrives (per each)	Pile Excavation (per linear ft)		
					In Soil	Not In Soil	
End Bent # 1	yes				47	23	X
End Bent # 2	yes				0	0	
TOTALS			0	0	47	23	0

**Notes:**

Blanks or "no" represent quantity of zero.

If steel pile points are required, calculate quantity of "Steel Pile Points" as equal to the number of steel piles.

If pipe pile plates are or may be required, calculate the quantity of "Pipe Pile Plates" as equal to the number of pipe piles.

Show quantity of "PDA Testing" on the plans as total only.

If quantity of "PDA Testing" is 3 or less, reference "Pile Driving Criteria" provision in PDA notes on plans and include "Pile Driving Criteria" provision in the contract.

**DRILLED PIER PAY ITEMS**  
**(For LRFD Projects - Revised 4/18/11)**

WBS ELEMENT 17BP.5.R.35  
 TIP NO. SF-910201  
 COUNTY Wake  
 STATION 13+70.00 -L-

DATE 9/12/2012  
 DESIGNED BY NAA  
 CHECKED BY CMK

DESCRIPTION Bridge No. 201 on SR 2368 over Little River  
Between SR 2407 and SR 2450

NUMBER OF BENTS WITH DRILLED PIERS 2  
 NUMBER OF DRILLED PIERS PER BENT 3  
 NUMBER OF END BENTS WITH DRILLED PIERS \_\_\_\_\_  
 NUMBER OF DRILLED PIERS PER END BENT \_\_\_\_\_

Bent # or End Bent #	DRILLED PIER PAY ITEM QUANTITIES				
	36" Dia. Drilled Piers Not In Soil (per linear ft/m)	Permanent Steel Casing For 36" Dia. Drilled Pier (yes/no/maybe)	SID Inspections (per each)	SPT Testing (per each)	CSL Testing (per each)
Bent 1	30	yes			
Bent 2	25	yes			
<b>TOTALS</b>	<b>55</b>	<del>                    </del>	<b>1</b>	<b>1</b>	<b>1</b>

Notes:

Blanks or "no" represent quantity of zero.

If drilled piers not in soil are required, calculate quantity of "36" Dia. Drilled Piers in Soil" as the difference between the total drilled pier length and the "36" Dia. Drilled Piers Not in Soil" from the table above. If there is none or zero quantity for drilled piers not in soil in the table above, calculate quantity of "36" Dia. Drilled Piers" as the total drilled pier length and do not use the "36" Dia. Drilled Piers in Soil" pay item.

If permanent steel casing is or may be required, calculate quantity of "Permanent Steel Casing for 36" Dia. Drilled Pier" as the difference between the ground line or top of drilled pier elevation, whichever is higher, and the elevation the permanent casing can not extend below from the foundation recommendations.

If "SID Inspections", "SPT Testing" or "CSL Testing" may be required, show quantities of these pay items on the substructure plans as totals only. If "SID Inspections", "SPT Testing" or "CSL Testing" is required, show quantities of these pay items on the substructure plans for each bent or end bent.

The number of CSL tubes required per drilled pier is equal to one tube per foot of design pier diameter with at least four tubes per pier. Calculate the length of each CSL tube as the total drilled pier length plus 1.5 ft.

**STATE OF NORTH CAROLINA**  
**DEPARTMENT OF TRANSPORTATION**  
**DIVISION OF HIGHWAYS**  
**GEOTECHNICAL ENGINEERING UNIT**

**STRUCTURE**  
**SUBSURFACE INVESTIGATION**

PROJ. REFERENCE NO. 17BP.S.R.35 (SF-910201) F. A. PROJ. N/A  
 COUNTY WAKE  
 SITE DESCRIPTION BRIDGE NO. 201 ON -L- (SR 2368) OVER  
LITTLE RIVER AT STA. 13 + 70

SHEET	DESCRIPTION
1	TITLE SHEET
2	LEGEND
3	SITE PLAN
4	PROFILE
5-6	CROSS SECTIONS)
7-11	BORE LOG & CORE REPORT(S)
12	ROCK TEST RESULTS
13	CORE PHOTOGRAPHS)
14	SITE PHOTOGRAPH

**CAUTION NOTICE**

THE SUBSURFACE INVESTIGATION HAS BEEN MADE IN ACCORDANCE WITH THE REQUIREMENTS OF THE SUBSURFACE INVESTIGATION ACT, WHICH IS BASED UPON THE ASSUMPTION THAT THE INFORMATION OBTAINED FROM THIS INVESTIGATION IS TO BE USED FOR THE PURPOSES OF DESIGNING AND CONSTRUCTING THE PROPOSED STRUCTURE AND NOT FOR ANY OTHER PURPOSES. THE INFORMATION OBTAINED FROM THIS INVESTIGATION IS TO BE USED FOR THE PURPOSES OF DESIGNING AND CONSTRUCTING THE PROPOSED STRUCTURE AND NOT FOR ANY OTHER PURPOSES. THE INFORMATION OBTAINED FROM THIS INVESTIGATION IS TO BE USED FOR THE PURPOSES OF DESIGNING AND CONSTRUCTING THE PROPOSED STRUCTURE AND NOT FOR ANY OTHER PURPOSES.

PERSONNEL

O. R. OTT

H. R. CONLEY

J. R. MATULA

H. L. PROBERTS

INVESTIGATED BY J. L. PEDRO

CHECKED BY M. T. ROBERSON

SUBMITTED BY J. L. PEDRO

DATE SEPTEMBER 2012

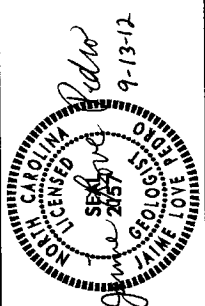

**PROJECT: 17BP.S.R.35**

**ID: SF-910201**

NOTE - THE INFORMATION CONTAINED HEREIN IS NOT TO BE GUARANTEED BY THE N.C. DEPARTMENT OF TRANSPORTATION AND SHALL BE USED AT THE USER'S RISK. THE USER SHALL BE RESPONSIBLE FOR VERIFYING THE ACCURACY OF THE INFORMATION CONTAINED HEREIN AND THE ACTUAL CONDITIONS AT THE PROJECT SITE.

DRAWN BY: T. F. WALKER, J. L. PEDRO

NORTH CAROLINA DEPARTMENT OF TRANSPORTATION
DIVISION OF HIGHWAYS
GEOTECHNICAL ENGINEERING UNIT

SUBSURFACE INVESTIGATION

Main data table with columns: SOIL DESCRIPTION, SOIL AND ROCK LEGEND, SOIL AND ROCK LEGEND, TERMS, SYMBOLS, AND ABBREVIATIONS, ROCK DESCRIPTION, TERMS AND DEFINITIONS.

PROJECT REFERENCE NO. SHEET  
17BP.S.R.35 3

# SITE PLAN



SKIEW ANGLE = 90°

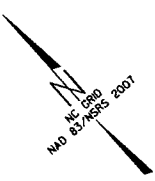
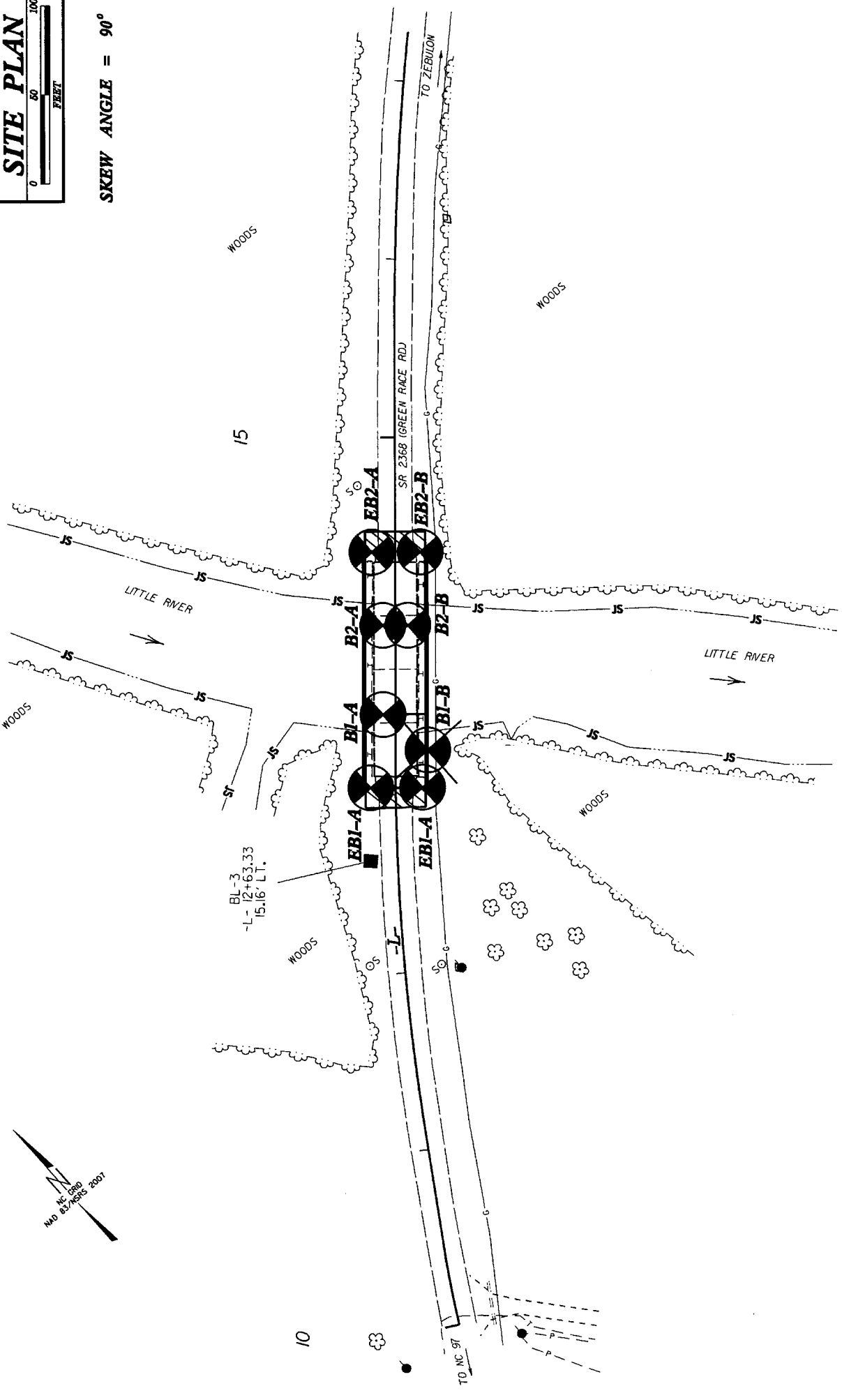

10

TO NC ST

TO ZEBULON



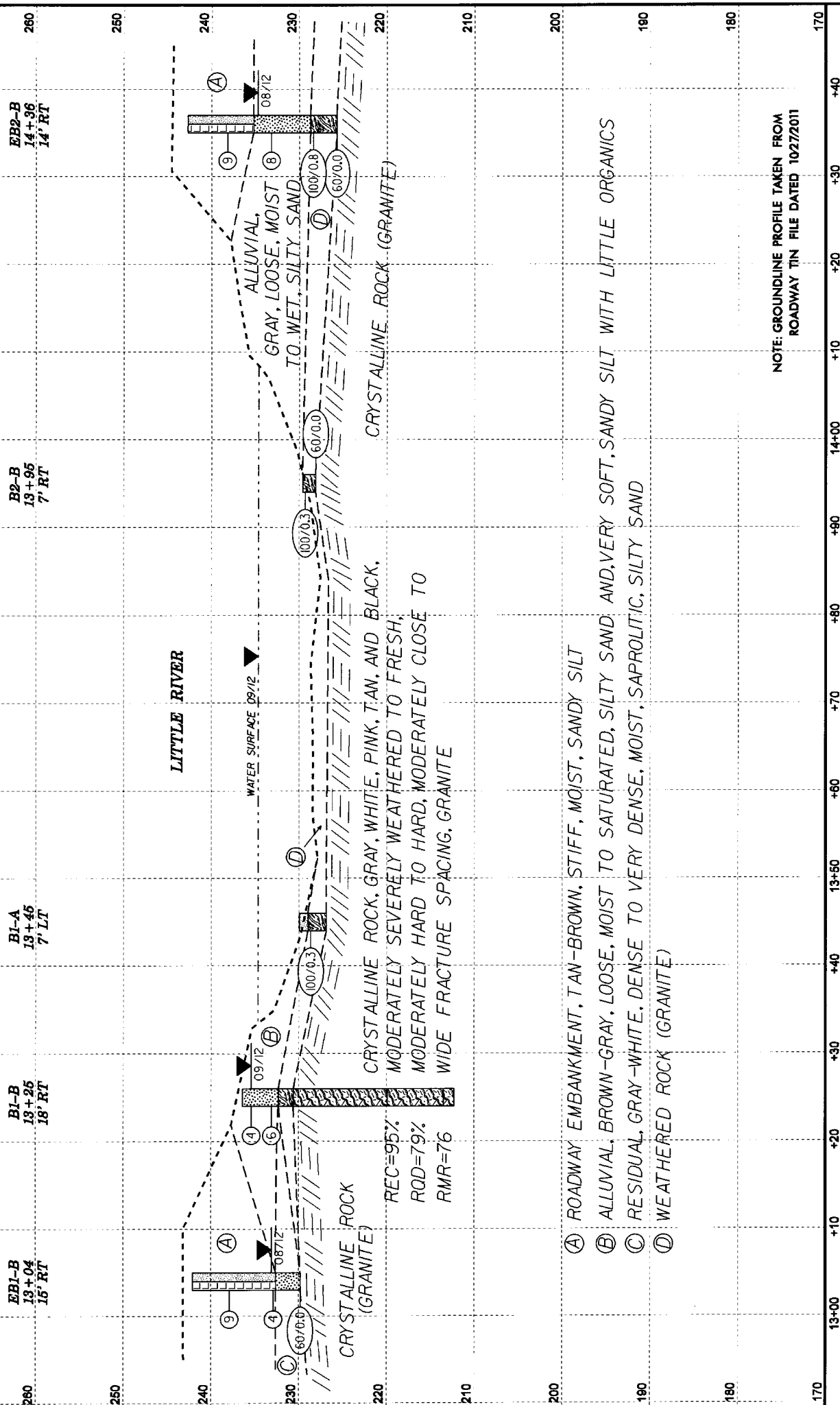

NOTE: GROUNDLINE PROFILE TAKEN FROM ROADWAY TIN FILE DATED 10/27/2011

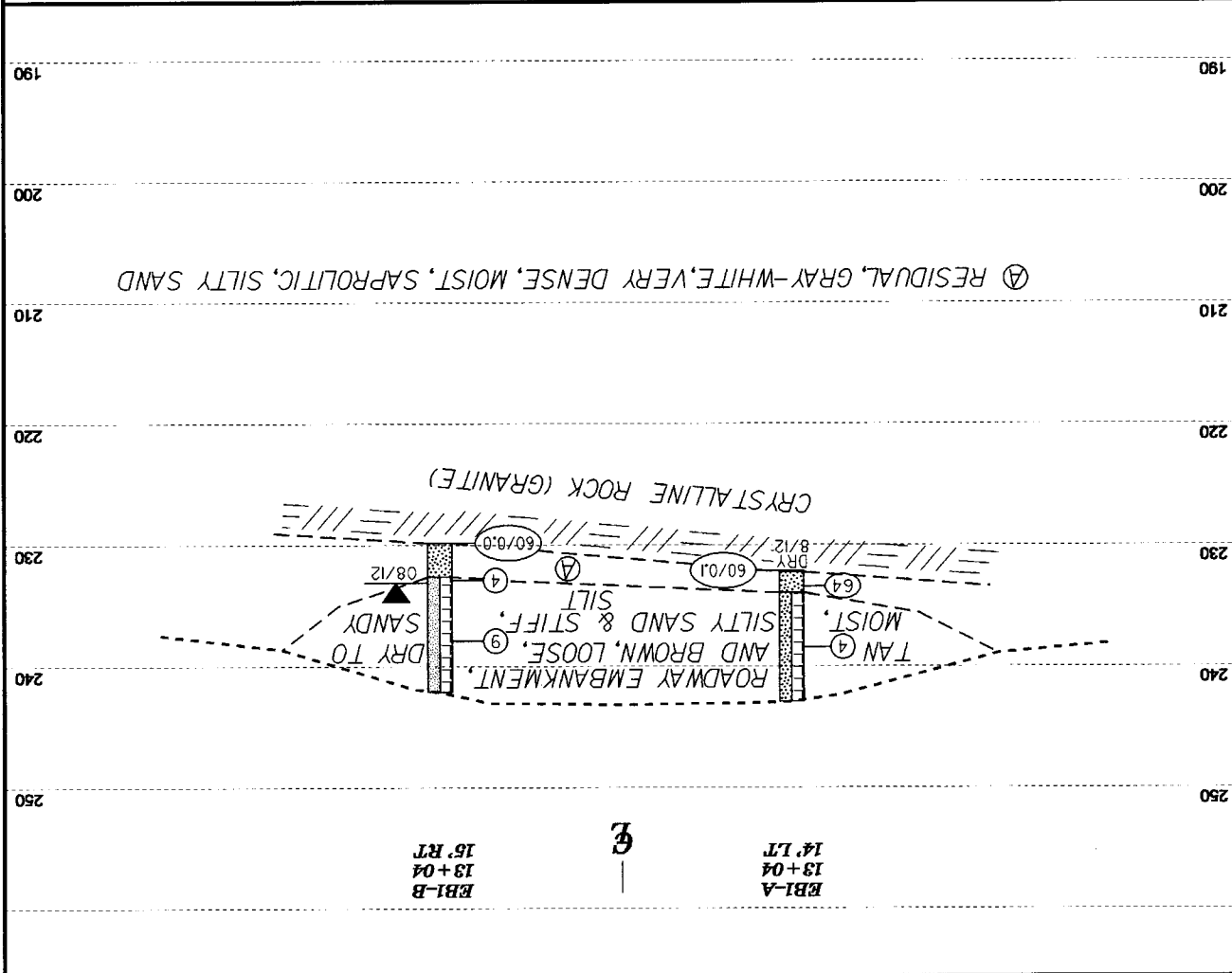
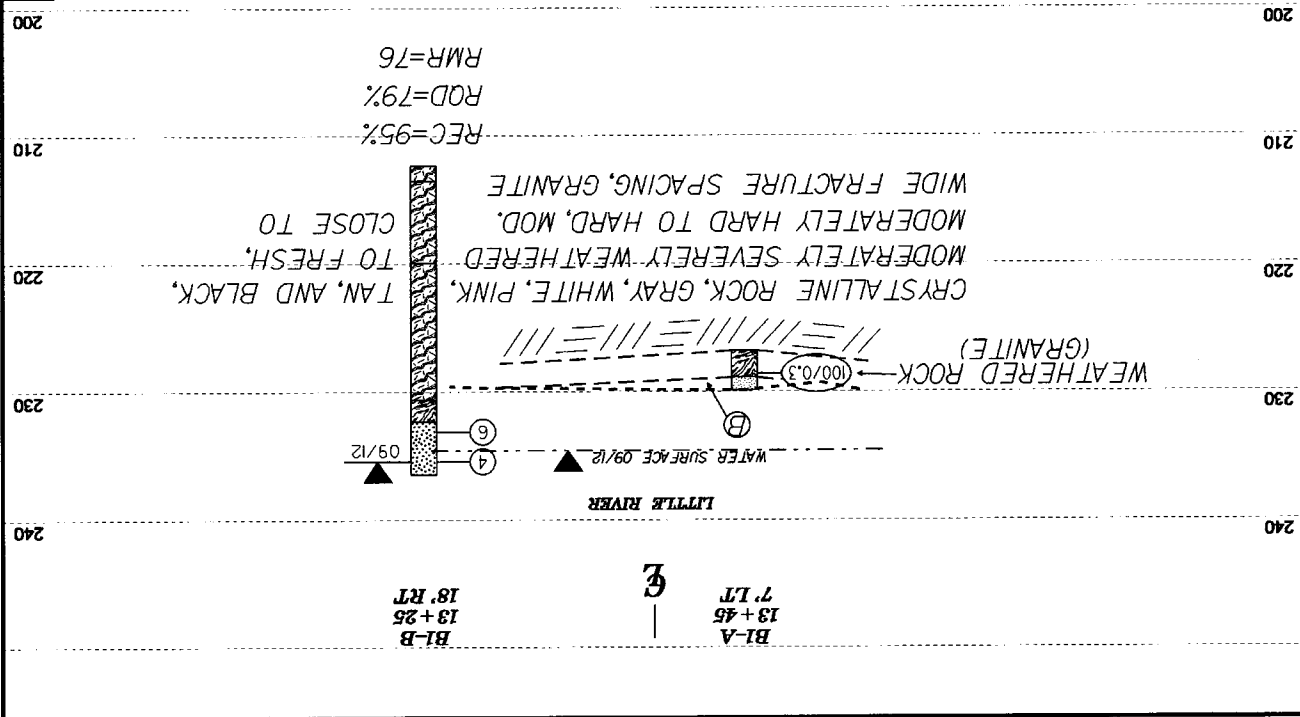

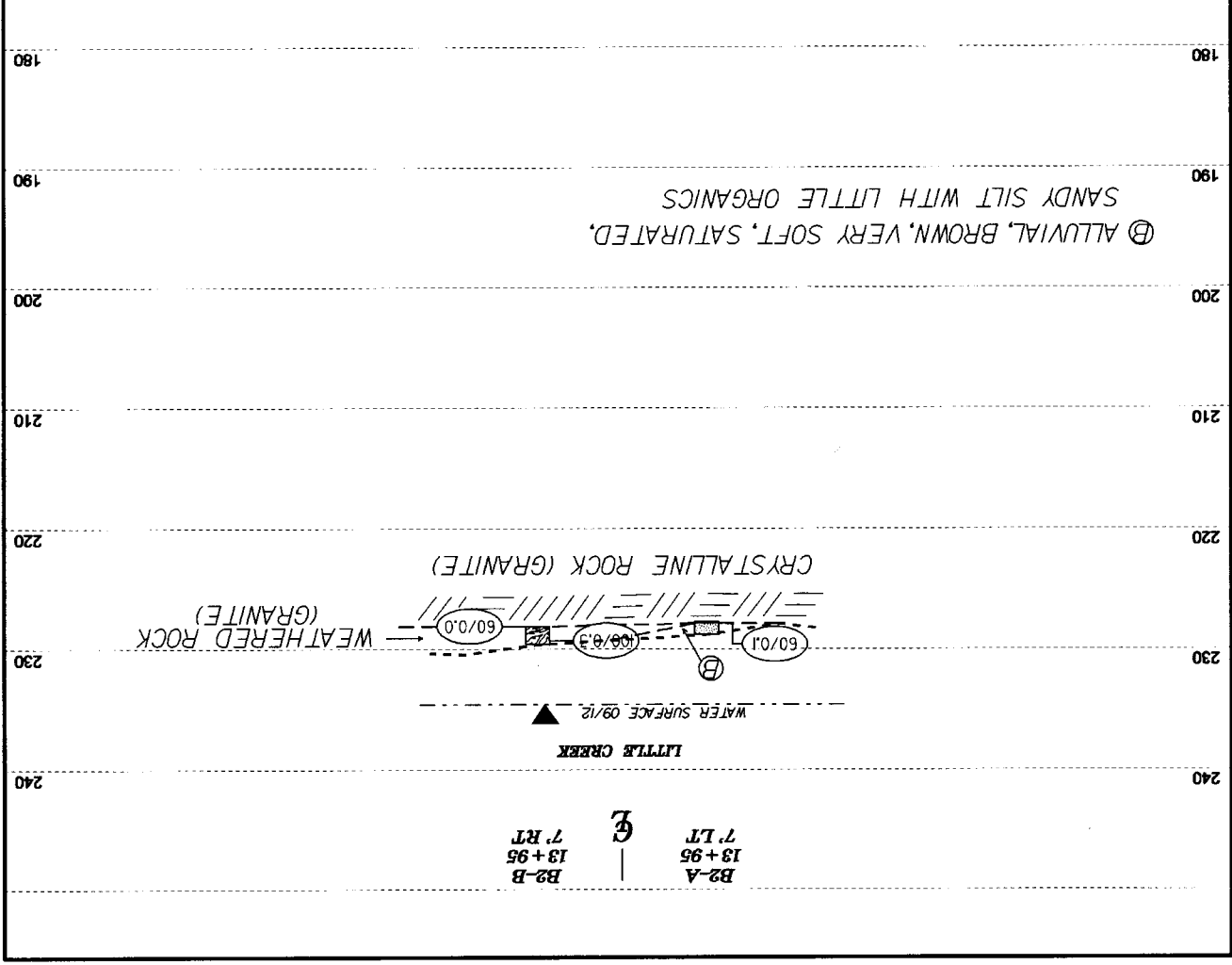
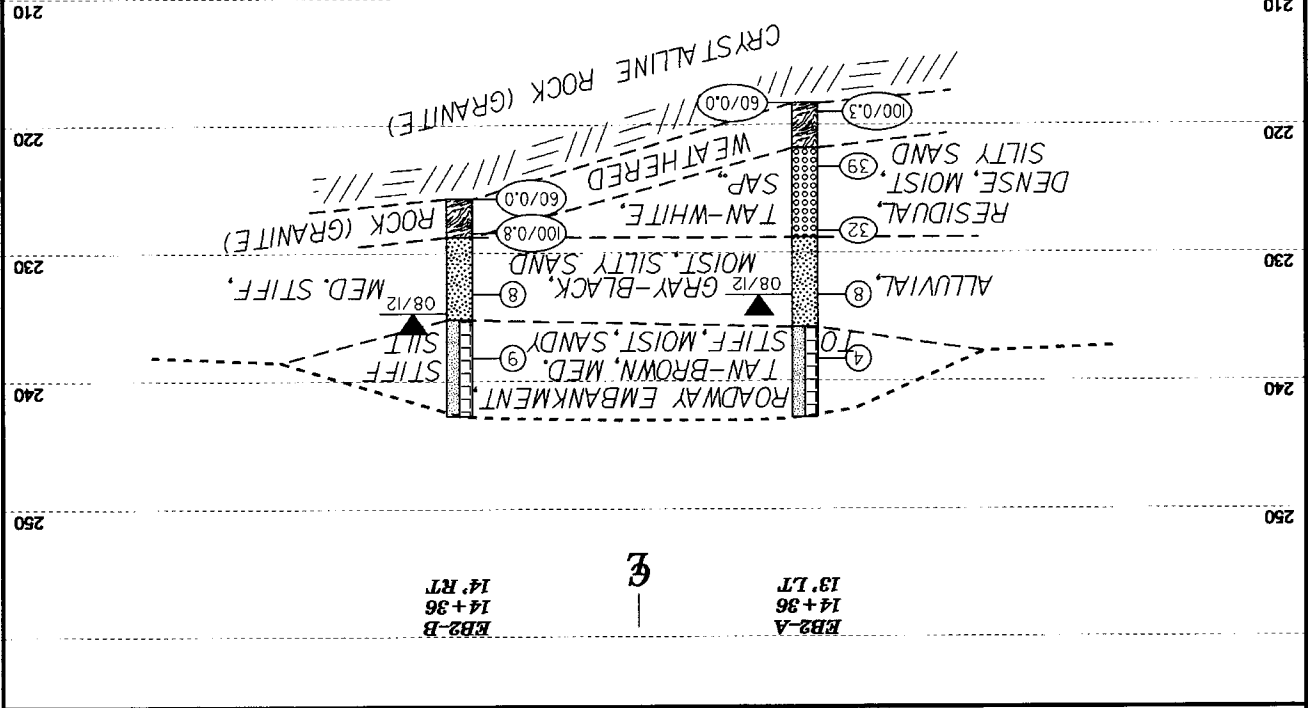



**NCDOT GEOTECHNICAL ENGINEERING UNIT  
BORELOG REPORT**

WBS 17BP-5.R-35		TIP SF-910201		COUNTY WAKE		GEOLOGIST Ohi, O. B.	
SITE DESCRIPTION BRIDGE NO. 201 ON L- (SR 2388, GREEN PACE ROAD) OVER LITTLE RIVER				GROUND WTR (ft)			
BORING NO. EB1-A		STATION 13+04		OFFSET 14 R.L.T.		ALIGNMENT -L-	
COLLAR ELEV. 242.9 ft		TOTAL DEPTH 10.8 ft		NORTHING 756,924		EASTING 2,191,721	
DRILL RIG/HAMMER EFF./DATE RFO0074/CME-55 92% 07/12/2011				DRILL METHOD H.S. Augers		HAMMER TYPE Automatic	
DRILLER Conley, H. R.		START DATE 08/29/12		COMP. DATE 08/29/12		SURFACE WATER DEPTH N/A	
DRIVE ELEV (ft)	DEPTH (ft)	BLOW COUNT	BLOWS PER FOOT	SAMP NO.	SOIL AND ROCK DESCRIPTION	DEPTH (ft)	GROUND WTR (ft)
245							
240	3.5	1	2		GROUND SURFACE ROADWAY EMBANKMENT TAN-BROWN, SILTY SAND	0.0	0.0
235	8.5	2	5		RESIDUAL GRAY-WHITE, SAPROLITIC, SILTY SAND	9.0	9.0
232.2	10.7	59	600.1		CRYSTALLINE ROCK (GRANITE)	10.7	10.7

Boring Terminated with Standard Penetration Test Refusal at Elevation 232.1 ft in CRYSTALLINE ROCK (GRANITE)

WBS 17BP-5.R-35		TIP SF-910201		COUNTY WAKE		GEOLOGIST Ohi, O. B.	
SITE DESCRIPTION BRIDGE NO. 201 ON L- (SR 2388, GREEN PACE ROAD) OVER LITTLE RIVER				GROUND WTR (ft)			
BORING NO. EB1-B		STATION 13+04		OFFSET 15 R.R.T.		ALIGNMENT -L-	
COLLAR ELEV. 242.1 ft		TOTAL DEPTH 12.3 ft		NORTHING 756,906		EASTING 2,191,743	
DRILL RIG/HAMMER EFF./DATE RFO0074/CME-55 92% 07/12/2011				DRILL METHOD H.S. Augers		HAMMER TYPE Automatic	
DRILLER Conley, H. R.		START DATE 08/29/12		COMP. DATE 08/29/12		SURFACE WATER DEPTH N/A	
DRIVE ELEV (ft)	DEPTH (ft)	BLOW COUNT	BLOWS PER FOOT	SAMP NO.	SOIL AND ROCK DESCRIPTION	DEPTH (ft)	GROUND WTR (ft)
245							
240	3.2	3	4		GROUND SURFACE ROADWAY EMBANKMENT TAN-BROWN, SANDY SILT	0.0	0.0
235	8.2	1	2		RESIDUAL GRAY-WHITE, SAPROLITIC, SILTY SAND	9.5	9.5
230	12.3	600.0	600.0		CRYSTALLINE ROCK (GRANITE)	12.3	12.3

Boring Terminated with Standard Penetration Test Refusal at Elevation 229.8 ft on CRYSTALLINE ROCK (GRANITE)

WBS 17BP.5.R.35		TIP SF-910201		COUNTY WAKE		GEOLOGIST Pedro, J. L.		
SITE DESCRIPTION BRIDGE NO. 201 ON L- (SR 2368, GREEN PACE ROAD) OVER LITTLE RIVER				ALIGNMENT -L-		GROUND WTR (ft)		
BORING NO. B1-A		STATION 13+45		OFFSET 7 ft LT		0 HR. N/A		
COLLAR ELEV. 229.9 ft		TOTAL DEPTH 3.1 ft		NORTHING 756.951		EASTING 2,191,753		
DRILL RIG/HAMMER EFF./DATE RFO0074 CME:55 92% 07/12/2011				DRILL METHOD NW Casing w/ SPT		HAMMER TYPE Automatic		
DRILLER Conley, H. R.		START DATE 09/05/12		COMP. DATE 09/05/12		SURFACE WATER DEPTH 4.4ft		
DRIVE ELEV (ft)	DEPTH (ft)	BLOW COUNT		BLOWS PER FOOT		L	SOIL AND ROCK DESCRIPTION	
		0.5ft	1.0ft	25	50			MOI
230	229.9	0.0	1	1000.3	1000.3	1000.3	0.0	GROUND SURFACE
							0.0	ALLUVIAL BROWN, SANDY SILT WITH LITTLE ORGANICS
							1.0	WEATHERED ROCK (GRANITE)
							3.1	Boring Terminated at Elevation 228.8 ft on CRT'S FALLLINE ROCK (GRANITE) CASING BROKE OFF AT 3.1'
235								WATER SURFACE (09/05/12)

**NCDOT GEOTECHNICAL ENGINEERING UNIT  
BORELOG REPORT**

**NCDOT GEOTECHNICAL ENGINEERING UNIT  
CORE BORING REPORT**

WBS 17BP-5.R.35		COUNTY WAKE		GEOLOGIST Pedro, J. L.		
SITE DESCRIPTION BRIDGE NO. 201 ON -L- (SR 2368, GREEN PACE ROAD) OVER LITTLE RIVER						
BORING NO. B1-B		STATION 13+25		ALIGNMENT -L-		
COLLAR ELEV. 236.4 ft		TOTAL DEPTH 24.1 ft		EASTING 2,191,759		
DRILL RIG/HAMMER EFF./DATE RF00074 CME-55 92% 07/12/2011		DRILL METHOD NW Casing WISPT & Core		HAMMER TYPE Automatic		
DRILLER Conley, H. R.		START DATE 09/05/12		COMP. DATE 09/05/12		
CORE SIZE NX1/2		TOTAL RUN 18.3 ft		SURFACE WATER DEPTH N/A		
ELEV (ft)	DRIVE DEPTH (ft)	BLOW COUNT	BLOWS PER FOOT		SAMP NO.	REMARKS
			0-25	25-50		
240						
235	236.4	2	2	2	2	
230	234.1	2	2	2	4	
225						
220						
215						

ELEV (ft)	RUN DEPTH (ft)	DRILL RATE (ft/min)	REC (%)	SAMP NO.	REMARKS
230.6	5.8	1.187/1.0	(3.0)	(3.0)	GROUND SURFACE
227.3	9.1	0.554/1.0	91%	91%	ALLUVIAL BROWN GRAY, SILTY SAND
225	5.0	1.331/1.0	(5.0)	(4.6)	WEATHERED ROCK (GRANITE)
222.3	14.1	1.521/1.0	100%	92%	CRYSTALLINE ROCK (GRANITE)
220	5.0	1.587/1.0	(4.5)	(4.0)	GRAY, PINK, WHITE, AND BLACK, MODERATELY SEVERE WEATHERED, MODERATELY CLOSE FRACTURE SPACING, GRANITE
217.3	19.1	0.451/1.0	(2.9)	(2.9)	REC=97% ROD=93%
215	5.0	0.487/1.0	(4.8)	(4.8)	RMR=76
212.3	24.1	1.071/1.0	100%	100%	TAN, WHITE, AND BLACK, MODERATELY SEVERE WEATHERED, MODERATELY CLOSE FRACTURE SPACING, GRANITE
211.9					REC=49% ROD=52%
213.5					RMR=76
212.3					GRAY, PINK, WHITE, AND BLACK, FRESH, HARD, WIDE FRACTURE SPACING, GRANITE
					REC=100% ROD=100%
					RMR=76
					Boring Terminated at Elevation 212.3 ft in CRYSTALLINE ROCK (GRANITE)

**NCDOT GEOTECHNICAL ENGINEERING UNIT  
BORELOG REPORT**

WBS 17BP-5.R.35		TIP SF-910201		COUNTY WAKE		GEOLOGIST Orl, O. B.	
SITE DESCRIPTION BRIDGE NO. 201 ON I-85 (SR 2388, GREEN PACE ROAD) OVER LITTLE RIVER		STATION 13+95		OFFSET 7 FT RT		ALIGNMENT -L-	
BORING NO. B2-B		TOTAL DEPTH 1.5 FT		NORTHING 756,979		EASTING 2,191,797	
COLLAR ELEV. 229.8 FT		DRILL METHOD NW Casing w/ SPT		DRILL DATE 08/31/12		SURFACE WATER DEPTH 4.7 FT	
DRILL RIGHAMMER EFF./DATE RFO0074 CME-55 92% 07/12/2011		DRILLER Conley, H. R.		START DATE 09/20/12		COMP. DATE 08/31/12	
DRIVE ELEV (FT)	DEPTH (FT)	BLOW COUNT	BLOWS PER FOOT	SAMP. NO.	L	O	GROUND WTR (ft)
235	0.0	0	0				0 HR. N/A
230	229.6						24 HR. N/A
	228.1						Automatic
							SOIL AND ROCK DESCRIPTION
							WATER SURFACE (08/31/12)
							GROUND SURFACE WEATHERED ROCK (GRANITE)
							Boring Terminated with Standard Penetration Test Refusal at Elevation 228.1 ft on CRYSTALLINE ROCK (GRANITE)

WBS 17BP-5.R.35		TIP SF-910201		COUNTY WAKE		GEOLOGIST Orl, O. B.	
SITE DESCRIPTION BRIDGE NO. 201 ON I-85 (SR 2388, GREEN PACE ROAD) OVER LITTLE RIVER		STATION 13+95		OFFSET 7 FT LT		ALIGNMENT -L-	
BORING NO. B2-A		TOTAL DEPTH 1.1 FT		NORTHING 756,988		EASTING 2,191,786	
COLLAR ELEV. 228.8 FT		DRILL METHOD NW Casing w/ SPT		DRILL DATE 09/04/12		SURFACE WATER DEPTH 5.5 FT	
DRILL RIGHAMMER EFF./DATE RFO0074 CME-55 92% 07/12/2011		DRILLER Conley, H. R.		START DATE 09/04/12		COMP. DATE 09/04/12	
DRIVE ELEV (FT)	DEPTH (FT)	BLOW COUNT	BLOWS PER FOOT	SAMP. NO.	L	O	GROUND WTR (ft)
235	0.0	0	0				0 HR. N/A
230	227.8						24 HR. N/A
	227.7						Automatic
							SOIL AND ROCK DESCRIPTION
							WATER SURFACE (09/04/12)
							GROUND SURFACE ALLUVIAL BROWN, SANDY SILT WITH TRACE ORGANICS CRYSTALLINE ROCK (GRANITE)
							Boring Terminated with Standard Penetration Test Refusal at Elevation 227.7 ft on CRYSTALLINE ROCK (GRANITE)



**NCDOT GEOTECHNICAL ENGINEERING UNIT  
BORELOG REPORT**

WBS 17BP.5.R.35		TIP SF-910201		COUNTY WAKE		GEOLOGIST Orl. O. B.	
SITE DESCRIPTION BRIDGE NO. 201 ON L.-L. (SR 2368, GREEN PACE ROAD) OVER LITTLE RIVER				GROUND WTR (#)			
BORING NO. EB2-A		STATION 14+36		OFFSET 13 ft LT		ALIGNMENT -L-	
COLLAR ELEV. 242.8 ft		TOTAL DEPTH 24.5 ft		NORTHING 757,023		EASTING 2,191,809	
DRILL RICHAMMER EFF./DATE RFO0074.CME-55 92% 07/12/2011		DRILL METHOD H.S. Augers		HAMMER TYPE Automatic			
DRILLER Conley, H. R.		START DATE 08/29/12		COMP. DATE 08/29/12			
SURFACE WATER DEPTH N/A							
DRIVE ELEV (ft)	DEPTH (ft)	BLOW COUNT	BLOWS PER FOOT	SAMP NO.	SOIL AND ROCK DESCRIPTION	DEPTH (ft)	GROUND WTR (#)
245							0.0
240	239.3	2	2	2	GROUND SURFACE ROADWAY EMBANKMENT TAN-BROWN, SANDY SILT	242.8	9.5
235	234.3	3	3	3	ALLUVIAL GRAY-BLACK SILTY SAND	235.8	9.5
230	229.3	6	16	16	RESIDUAL TAN-WHITE, SAPROLITIC SILTY SAND	229.8	
225	224.3	51	24	15	WEATHERED ROCK (GRANITE)	221.8	
220	219.3	8000.0				218.3	

Boring Terminated with Standard Penetration Test Below at Elevation 218.3 ft on CRYSTALLINE ROCK (GRANITE)

WBS 17BP.5.R.35		TIP SF-910201		COUNTY WAKE		GEOLOGIST Orl. O. B.	
SITE DESCRIPTION BRIDGE NO. 201 ON L.-L. (SR 2368, GREEN PACE ROAD) OVER LITTLE RIVER				GROUND WTR (#)			
BORING NO. EB2-B		STATION 14+36		OFFSET 14 ft RT		ALIGNMENT -L-	
COLLAR ELEV. 242.7 ft		TOTAL DEPTH 17.0 ft		NORTHING 757,005		EASTING 2,191,829	
DRILL RICHAMMER EFF./DATE RFO0074.CME-55 92% 07/12/2011		DRILL METHOD H.S. Augers		HAMMER TYPE Automatic			
DRILLER Conley, H. R.		START DATE 08/30/12		COMP. DATE 08/30/12			
SURFACE WATER DEPTH N/A							
DRIVE ELEV (ft)	DEPTH (ft)	BLOW COUNT	BLOWS PER FOOT	SAMP NO.	SOIL AND ROCK DESCRIPTION	DEPTH (ft)	GROUND WTR (#)
245							0.0
240	239.2	3	3	3	GROUND SURFACE ROADWAY EMBANKMENT TAN-BROWN, SANDY SILT	242.7	9.1
235	234.2	4	5	5	ALLUVIAL GRAY SILTY SAND	235.2	8.0
230	229.2	3	10	3000.3	WEATHERED ROCK (GRANITE)	229.7	
225	225.2	8000.0				225.7	

Boring Terminated with Standard Penetration Test Below at Elevation 225.7 ft on CRYSTALLINE ROCK (GRANITE)



**PROJ. NO. - 17BP.5.R.35**  
**ID NO. - SF-910201**  
**COUNTY - WAKE**

**BI-B -L-**

**ROCK TEST RESULTS**

SAMPLE NO.	OFFSET	STATION	DEPTH INTERVAL	ROCK TYPE	UNIT WT LBFT <sup>3</sup>	UNCONFINED COMP. STRENGTH, KSI	SECTION MOD. @ 4% MPFSI
RS-1	18 RT	13+25	10.3-11.3	GRANITE	162.8	10.07	3.18

# CORE PHOTOGRAPHS

## B1-B BOXES 1 & 2: 5.8 - 24.1 FEET

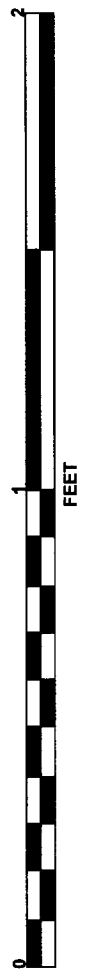
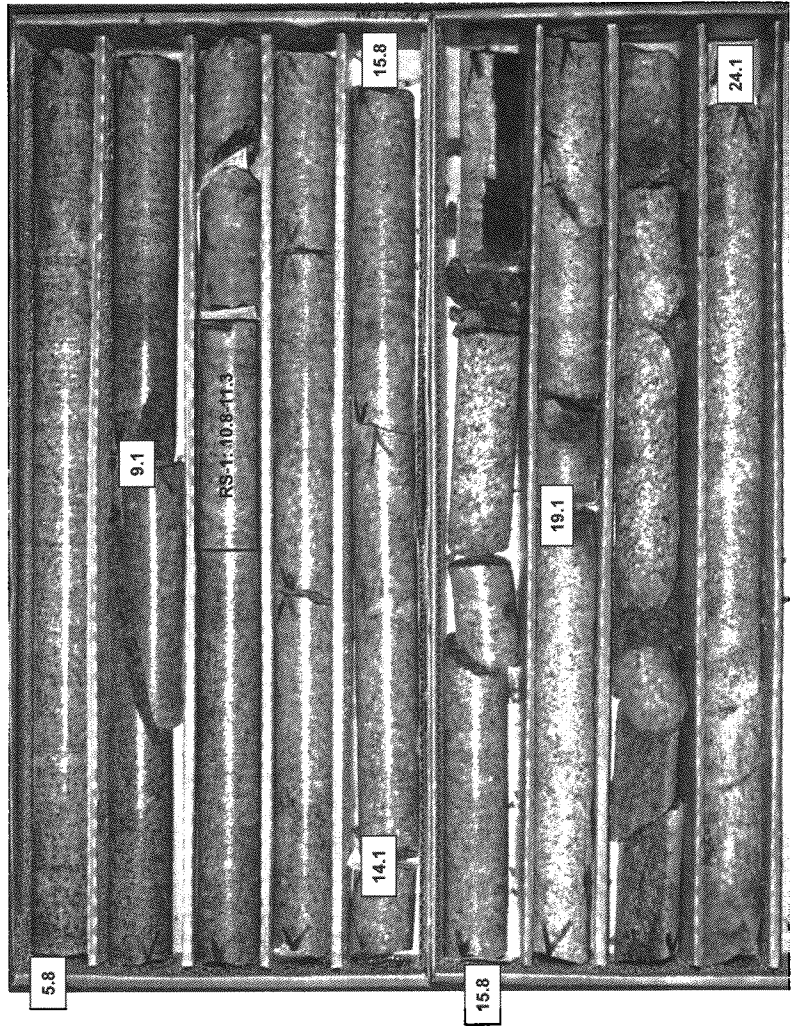

## SITE PHOTOGRAPH

Bridge No. 201 on -L- (SR 2368) over Little River



Looking North towards End Bent 2